

Analysis of 3-Phase Superconducting Fault Current Limiters in Power Systems With Inhomogeneous Quenching

Diaa-Eldin A. Mansour, *Member, IEEE*, and Doaa M. Yehia

Abstract—The limitation behavior of a 3-phase superconducting fault current limiter (SFCL) in power systems is greatly affected by inhomogeneous quenching among phases, where it can lead to increasing current limitation burden upon some phase units. Accordingly, this paper aims to analyze the behavior of SFCL with inhomogeneous quenching among phases. A model is developed for the resistive type SFCL using PSCAD/EMTDC software considering the transition from superconducting state to normal conducting state through flux flow state. Inhomogeneous quenching is represented in two different ways, either as an inhomogeneity in I_c value or an inhomogeneity in n value. Different types of faults including symmetrical and unsymmetrical faults are studied. For each case, the influence of inhomogeneous quenching on current limitation and corresponding voltage drop across units is evaluated. From the obtained results, it is found that the most severe case appears for line-to-line fault. Therefore, the effect of inhomogeneity degree is discussed for this fault type.

Index Terms—Current limitation burden, inhomogeneous quenching, superconducting fault current limiter (SFCL), symmetrical, unsymmetrical faults.

I. INTRODUCTION

WITH THE increased capacity of electrical power grids, fault current level exceeds the permissible limit of existing switchgear. As a promising solution, superconducting fault current limiter (SFCL) was developed with a fast progress over the last few years [1]. Among the different types of SFCLs, resistive type SFCL was widely used [2]–[4], due to its compact size and simple principle of operation. Resistive type SFCL is based on quenching process, which means the transition from superconducting to normal state (S-N transition). With YBCO coated conductors, the visibility of using resistive type SFCL has been increased due to the benefits of high current density and fast S-N transition.

During the fabrication of YBCO coated conductors, there are some defects such as holes or cracks on the surface of YBCO [5], [6]. These defects lead to inhomogeneous superconducting properties and consequently affect current limitation process [7]. The problem becomes more distinct with long length coated conductors [8]. The most affected parameters

Manuscript received October 9, 2012; accepted January 13, 2013. Date of publication January 15, 2013; date of current version February 6, 2013.

The authors are with the Department of Electrical Power and Machines Engineering, Faculty of Engineering, Tanta University, Tanta 31521, Egypt (e-mail: mansour@f-eng.tanta.edu.eg; dmyehia@f-eng.tanta.edu.eg).

Color versions of one or more of the figures in this paper are available online at <http://ieeexplore.ieee.org>.

Digital Object Identifier 10.1109/TASC.2013.2240431

by inhomogeneous superconducting properties are the critical current density J_c and the n value of E - J power law relation [9]. The inhomogeneity affects the current sharing when YBCO coated conductors are connected in parallel and affects the voltage sharing when they are connected in series.

When SFCL is used for 3-phase power system, the inhomogeneous superconducting properties will lead to inhomogeneous quenching. Then, current limitation burden upon some units may be increased depending on the fault type [10]. If the voltage across any unit reaches the voltage tolerance of YBCO coated conductors [11], this unit will be damaged.

From this point of view, this paper analyzes the current limitation behavior of 3-phase SFCL when it is encountered by inhomogeneous quenching. Simulations are conducted using PSCAD/EMTDC software. A model is developed for SFCL to take into account inhomogeneous quenching among the three phases. The system performance is studied under both symmetrical and unsymmetrical faults. The impact of inhomogeneous quenching on line currents and voltages across SFCL units is investigated for each fault type. The most severe case is determined, and then, is investigated at different degrees of inhomogeneity.

II. MODELING OF SFCL AND SYSTEM DESCRIPTION

A. Modeling of SFCL

The current limitation behavior of resistive type SFCL is achieved based on the transition from superconducting state to normal conducting state through flux flow state [12], [13]. The superconducting state is represented by zero resistance at current density J and temperature T below their critical values J_c and T_c . When the current density exceeds J_c , the superconductor enters flux flow state where it is heated up significantly. After the superconductor is heated up above T_c , it becomes at normal conducting state and its resistance grows as a function of temperature.

In this study, a model for resistive type SFCL was developed on PSCAD/EMTDC software considering all the above mentioned states. Fig. 1 illustrates the system under study in this paper integrated with SFCL model. The model consists of three parallel branches as shown in Fig. 1. The first branch represents the superconducting state with zero resistance. A current-based controlled switch S, with normally closed status, is incorporated into this branch. When the current density exceeds J_c , the switch is opened and the current redirects to other branches.

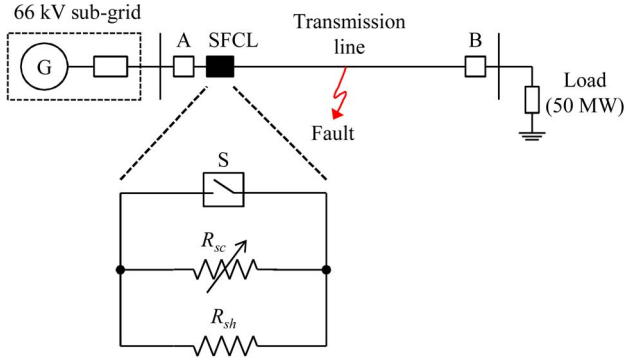

Fig. 1. System under study integrated with SFCL model.

The second branch is composed of a nonlinear resistance R_{sc} representing the transition to normal conducting state. The initial value of this resistance is set at zero. When the switch S is opened and the fault current starts to flow through R_{sc} , the resistance value increases according to two different regimes depending on the conductor temperature. The first regime represents the flux flow resistance which appears rapidly after fault according to the following equation for flux flow resistivity ρ_f [12]:

$$\rho_f = \frac{E_c}{J_c} \left(\frac{J}{J_c} \right)^n \quad (1)$$

where E_c is the critical field and n is the exponent of E - J power law. Usually the exponent n lies in the range above 20 [9].

After very short time, about 1 ~ 2 ms, the conductor is heated up to the critical temperature. Then, the resistance value moves to the second regime which represents the normal conducting resistance. This resistance varies approximately in a linear relationship with temperature. The temperature dependency of the flux flow and normal conducting resistances is derived from the thermal modeling of YBCO coated conductors as given by the following equation:

$$\frac{\partial T}{\partial t} = \frac{1}{C_p} (I_{sc}^2 R_{sc}) \quad (2)$$

where C_p is the heat capacity and I_{sc} is the superconductor current. Here the cooling of coated conductor by liquid nitrogen during fault duration is neglected [12].

The third branch of the developed model incorporates a shunt resistance R_{sh} that is needed to protect the superconductor from destructive hot spots during the quench and to avoid the higher overvoltages across the limiter. The value of shunt resistance was adjusted close to the value of normal conducting resistance.

B. System Under Study

The system used in the analysis of this paper consists of a 66 kV sub-grid connected to a load of 50 MW through a transmission line of 40 km length. The SFCL is installed just after circuit breaker A and its three phase units are modeled independently for each phase in order to simulate different quenching behavior.

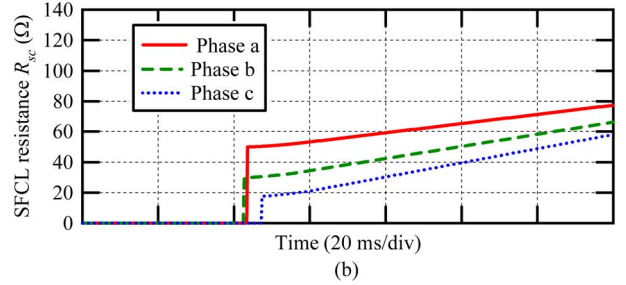
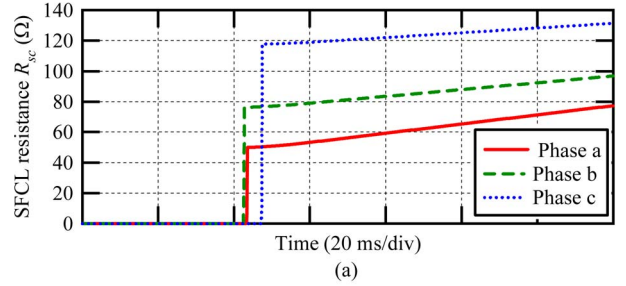

Fig. 2. Generated SFCL resistance for inhomogeneity in I_c and n values. (a) Inhomogeneity in I_c value. (b) Inhomogeneity in n value.

C. Inhomogeneous Quenching Simulation

Inhomogeneous superconducting properties are mainly reflected either on the critical current I_c or on the n value of E - J power law relation. So, to simulate inhomogeneous quenching, I_c and n are set at different values among the 3-phase units resulting in a difference of quenching resistance. The difference in resistance appears mainly in the flux flow resistance.

III. RESULTS AND DISCUSSION

The fault was simulated at the middle of the transmission line in Fig. 1. The analysis was carried out considering the following parameters: generated resistance, line currents and voltages across SFCL units. Different fault types were investigated. The fault instant was 0.2 s and its duration was 0.1 s before it was cleared by protection devices. The normal RMS current was 509 A, and the prospective peak fault currents were 5238 A on phase a, 5842 A on phase b and 6057 A on phase c. The nominal values of n and I_c were 20 and 1000 A, respectively. To investigate inhomogeneous quenching, a series of simulations have been carried out with SFCL units among phases having different I_c or n values. First, the values of I_c for phase b and phase c were set less than I_c for phase a by 2% and 4%, respectively. Then, I_c was kept the same for all SFCL units, and the values of n for phase b and phase c were decreased by 2% and 4%, respectively, than that for phase a. The generated SFCL resistance for the inhomogeneity in I_c and n values are depicted in Fig. 2. For all cases, the resistance increases rapidly after fault, within 1 ms, exhibiting the flux flow resistance, and then, increases linearly representing the normal conducting resistance. In Fig. 2(a), with inhomogeneity in I_c value, SFCL unit of phase c exhibited larger flux flow resistance as a result of smaller I_c value. In Fig. 2(b), with inhomogeneity in n value, SFCL unit of phase c exhibited lower flux flow resistance as a result of smaller n value. The shunt resistance R_{sh} was set to a fixed value of 50 Ω in all phases.

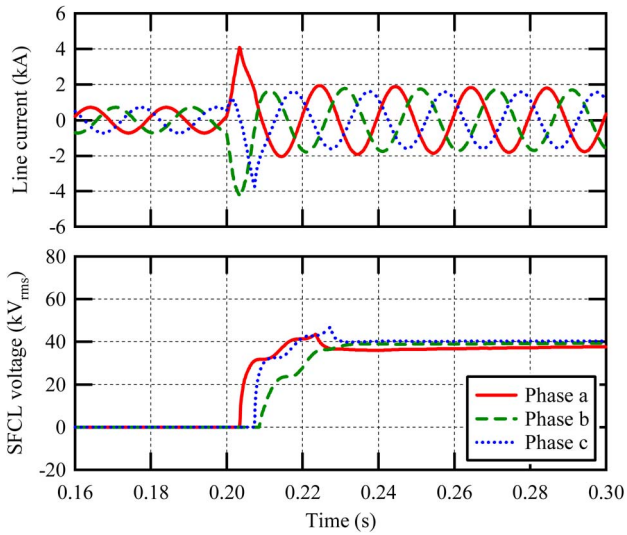

Fig. 3. Current limitation characteristics for symmetrical fault with inhomogeneity in I_c values.

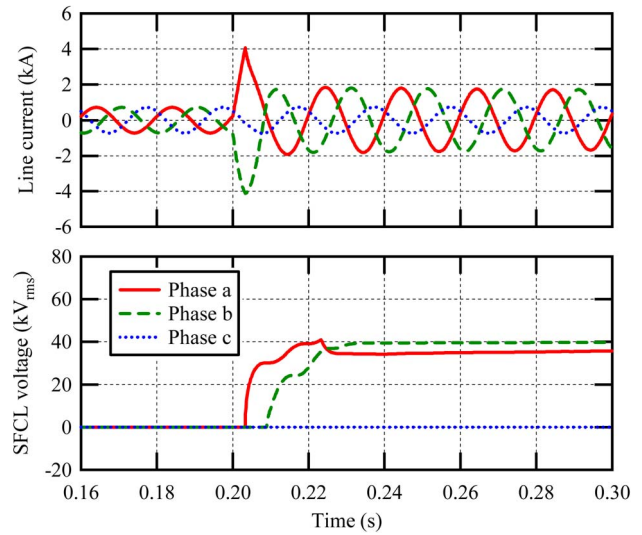

Fig. 5. Current limitation characteristics for double line-to-ground fault with inhomogeneity in I_c values.

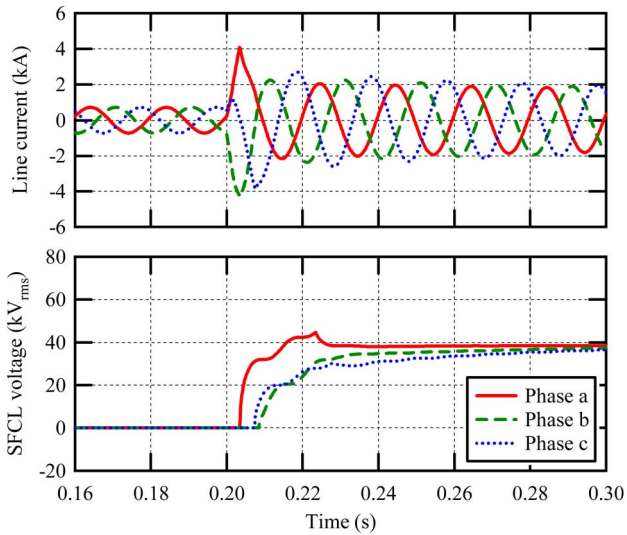

Fig. 4. Current limitation characteristics for symmetrical fault with inhomogeneity in n values.

A. Symmetrical Three Phase Fault

For symmetrical fault, the current limitation characteristics are shown in Fig. 3, with inhomogeneity in I_c values. The difference in I_c values will be reflected on the opening instant of the switch S in each phase as well as the value of generated SFCL resistance. As shown in Fig. 3, the difference in generated SFCL resistance caused unbalanced line currents, where the line current on phase c was a little bit lower than other phases due to higher limiting resistance. For voltages across SFCL units, they had approximately the same values of phase voltages for the transmission line, except a slight transient overshoot appeared directly after quenching.

On the other hand, Fig. 4 shows the current limitation characteristics with inhomogeneity in n values. The inhomogeneity caused unbalanced line currents as well as unbalanced voltages across SFCL units. But, in inverse to the tendency obtained in Fig. 3, the line current on phase c was higher than other phases due to lower limiting resistance.

B. Unsymmetrical Faults to Ground

Unsymmetrical faults to ground include double line-to-ground fault and single line-to-ground fault. These types of faults are the most frequently types that occur into transmission lines. For double line-to-ground fault with inhomogeneity in I_c values, the line currents and voltages across SFCL units are shown in Fig. 5. The fault was considered between phase a and phase b to ground with a decrease of I_c by 2% on phase b . It is clear that the results on the faulted phases are nearly within the same range of that with symmetrical fault. This is because the line currents and consequently, the generated SFCL resistances of the faulted phases were contributed due to phase-to-ground voltages. However, SFCL unit on the healthy phase, phase c , was not quenched due to small line current. Also, for inhomogeneity in n values, line currents and voltages across SFCL units of phases a and b were similar to that in Fig. 4.

For single line-to-ground fault, similar observations have been obtained for phase a , the faulted phase. It is important to point out that, with single line-to-ground fault, the full line-to-line voltage will appear on the other two phases. But, this will not affect the voltages across SFCL units in these phases since the current following through these units is small and not sufficient to cause quenching.

C. Line-to-Line Fault

When a line-to-line fault occurs, only the SFCL units on the faulted phases will be quenched. If quenching occurred simultaneously, this type of fault will exhibit the lowest line currents and voltages across SFCL units. If inhomogeneous quenching has been encountered as an inhomogeneity in I_c value by 2%, the voltage across SFCL unit of phase b was slightly higher than that of phase a as shown in Fig. 6, but both voltages were within a safe range. However, if an inhomogeneity in n values has been occurred by the same percentage, a lower resistance would be built up for SFCL unit of phase b . This caused a severe current limitation burden on SFCL unit of phase a , as shown in Fig. 7.

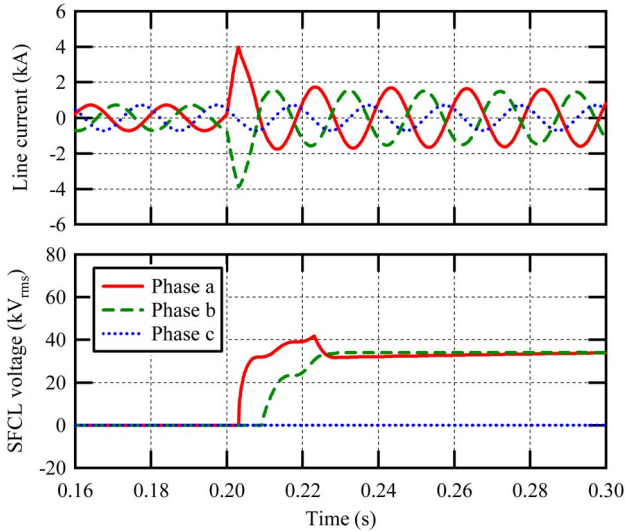

Fig. 6. Current limitation characteristics for line-to-line fault with inhomogeneity in I_c values.

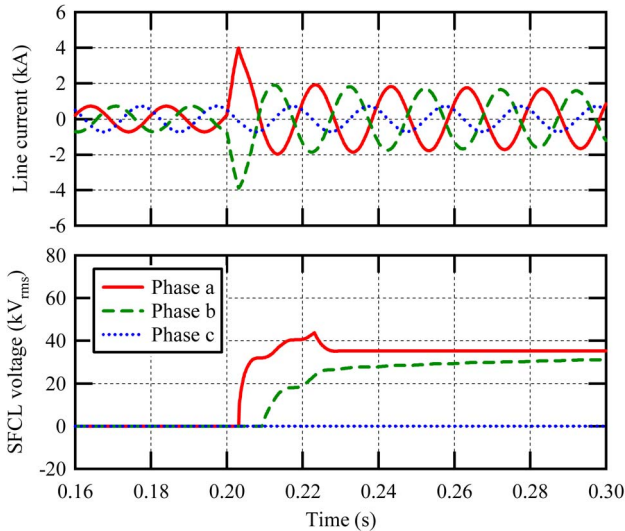

Fig. 7. Current limitation characteristics for line-to-line fault with inhomogeneity in n values.

In addition, the line currents were higher than that in Fig. 6, as a result of reducing the total limiting resistance between phase a and phase b.

D. Effect of Inhomogeneity Degree

It is clear that the most severe effect of inhomogeneous quenching appeared for line-to-line fault. Therefore, extensive investigations were performed to determine the effect of inhomogeneity degree for this fault type. Fig. 8 shows the effect of inhomogeneity degree, either in I_c or n values, on the maximum voltages across SFCL units. The voltage was captured after two cycles of fault instant in order to bypass the transient overshoot. With inhomogeneity in I_c values, the maximum voltage appears on phase b, while, with inhomogeneity in n values, the maximum voltage appears on phase a. For both cases, the maximum voltage across SFCL units increases with increasing the inhomogeneity degree. Above inhomogeneity

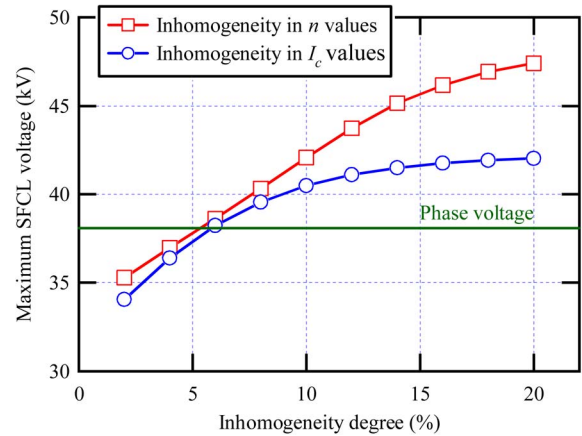

Fig. 8. Effect of inhomogeneity degree on the maximum SFCL voltage.

degree of about 6%, the maximum voltage goes beyond the nominal phase voltage, resulting in a severe condition on the corresponding SFCL unit. The effect of inhomogeneity in n values is more pronounced than that of inhomogeneity in I_c values. This can be attributed to the effect of shunt resistance, where it alleviates the increase of limiting resistance at smaller I_c values.

IV. CONCLUSION

The current limitation behavior of 3-phase SFCL has been analyzed when inhomogeneous quenching among phases had been occurred. A model for resistive type SFCL was developed simulating inhomogeneity either in I_c or n values. SFCL unit of smaller I_c value exhibited larger flux flow resistance, while, SFCL unit of smaller n value exhibited lower flux flow resistance. Different fault types have been investigated. For symmetrical three phase faults and unsymmetrical faults to ground, the voltages across SFCL units have been within a safe range. However, for line-to-line fault, the voltage across SFCL units increased to a severe condition. The effect of inhomogeneity degree has been studied. With increasing the inhomogeneity degree, the maximum voltage across SFCL units increased beyond the nominal phase voltage. The maximum possible voltage that can appear across SFCL units should be considered during the design stage in order to operate SFCL safely within its voltage tolerance values.

REFERENCES

- [1] M. Noe and M. Steurer, "High-temperature superconductor fault current limiters: Concepts, applications, and development status," *Supercond. Sci. Technol.*, vol. 20, no. 3, pp. R15–R29, Mar. 2007.
- [2] B. Gromoll, G. Ries, W. Schmidt, H.-P. Kraemer, B. Seebacher, B. Utz, R. Nies, H.-W. Neumueller, E. Baltzer, S. Fischer, and B. Heismann, "Resistive fault current limiters with YBCO Films—100 kVA functional model," *IEEE Trans. Appl. Supercond.*, vol. 9, no. 2, pp. 656–659, Jun. 1999.
- [3] D. K. Park, S. E. Yang, Y. S. Yoon, M. C. Ahn, H. M. Kim, Y. S. Kim, J.-W. Park, and T. K. Ko, "Analysis of the operational characteristics of a resistive SFCL by using the YBCO coated conductor," *IEEE Trans. Appl. Supercond.*, vol. 17, no. 2, pp. 1851–1854, Jun. 2007.
- [4] A. Kudymow, M. Noe, C. Schacherer, H. Kinder, and W. Prusseit, "Investigation of YBCO coated conductor for application in resistive superconducting fault current limiters," *IEEE Trans. Appl. Supercond.*, vol. 17, no. 2, pp. 3499–3502, Jun. 2007.

- [5] Y. G. Zhou, L. Y. Xiao, G. M. Zhang, Z. C. Zhang, X. H. Li, L. Z. Lin, Z. F. Zhang, and S. T. Dai, "Simulation of inhomogeneous superconducting properties of YBCO HTS tapes," *IEEE Trans. Appl. Supercond.*, vol. 20, no. 3, pp. 1250–1253, Jun. 2010.
- [6] V. Meerovich, V. Sokolovsky, M. Gladstein, and S. Shtutina, "Quench development in thin inhomogeneous HTS film on sapphire substrate," *Phys. C*, vol. 366, no. 4, pp. 291–298, Feb. 2002.
- [7] Y. Ichiki and H. Ohsaki, "Influence of inhomogeneous superconducting properties of YBCO thin film on current limiting characteristics," *IEEE Trans. Appl. Supercond.*, vol. 17, no. 2, pp. 1811–1814, Jun. 2007.
- [8] S. Y. Chu, J. Y. Jang, S. Choi, Y. J. Kim, K. S. Chang, and T. K. Ko, "Experimental analysis of unequal voltage distribution on a single YBCO coated conductor affected by inhomogeneous critical currents in liquid nitrogen and sub-cooled liquid nitrogen," *IEEE Trans. Appl. Supercond.*, vol. 21, no. 3, pp. 2992–2996, Jun. 2011.
- [9] Z. Hong, Z. Jin, M. Ainslie, J. Sheng, W. Yuan, and T. A. Coombs, "Numerical analysis of the current and voltage sharing issues for resistive fault current limiter using YBCO coated conductors," *IEEE Trans. Appl. Supercond.*, vol. 21, no. 3, pp. 1198–1201, Jun. 2011.
- [10] H.-S. Choi, S.-H. Lim, D.-C. Chung, B.-S. Han, O.-B. Hyun, T.-H. Sung, and J.-S. Hwang, "Responses of resistive superconducting-fault-current-limiters to unbalanced faults," *IEEE Trans. Appl. Supercond.*, vol. 15, no. 2, pp. 2035–2038, Jun. 2005.
- [11] B. Lin, L. Ying, J. Sheng, J. Zhang, L. Yao, Y. Li, Z. Jin, and Z. Hong, "Test of maximum endurable quenching voltage of YBCO-coated conductors for resistive superconducting fault current limiter," *IEEE Trans. Appl. Supercond.*, vol. 22, no. 3, p. 5602904, Jun. 2012.
- [12] K. Nam, C. Lee, D. K. Park, T. K. Ko, and B.-Y. Seok, "Thermal and electrical analysis of coated conductor under AC over-current," *IEEE Trans. Appl. Supercond.*, vol. 17, no. 2, pp. 1923–1926, Jun. 2007.
- [13] S. M. Blair, C. D. Booth, and G. M. Burt, "Current-time characteristics of resistive superconducting fault current limiters," *IEEE Trans. Appl. Supercond.*, vol. 22, no. 2, p. 5600205, Apr. 2012.