

A Novel LQR Based Optimal Tuning Method for IMP-Based Linear Controllers of Power Electronics/Power Systems

A. Hasanzadeh, *Member, IEEE*, C. S. Edrington, *Senior Member, IEEE*, and H. Mokhtari, *Member, IEEE*

Abstract-- This paper presents a new method for tuning linear controllers such as Proportional-Integrating (PI) and Proportional-Resonant (PR) structures which are frequently used in different power electronic and power system applications. Those controllers are placed within a general structure offered by the Internal Model Principle (IMP) of control theory. In this paper, the first perspective uses the well-known concept of Linear Quadratic Regulator (LQR) to address the problem as a regulation problem. Matrix Q of the LQR design is then finely adjusted in order to assure desired transient response for the system. The second perspective is based on redefining the LQR problem in order to make it capable of addressing the optimal tracking problem. Two specific examples of the method applications, one in a UPS inverter system and the other one in a DG system, as applied to tuning of a PR and a PI controller are studied in detail. Both examples are simulated in PSCAD and the results confirm analytical derivations.

Index Terms— Tuning linear controllers, PI, PID, PR, optimal control, LQR, UPS inverter, DG.

I. INTRODUCTION

POWER electronics and power system applications use different forms of controllers such as PI, PID and PR controllers to achieve control objectives mainly specified by desirable transient and steady-state specifications. Such structures originate from the IMP of control theory. The IMP states that a model of the desired commands (and disturbances) must exist in the loop to ensure desired steady-state operation [1]. Thus, a PI (or PID) controller is appropriate for step references and a PR controller for sinusoidal references. The IMP, however, only guarantees the steady-state performance. The transient response must be controlled by appropriate selection of the controller gains.

Applications of specified-structures controllers such as PI, PID and PR in power systems and power electronics abound. Some examples are given below without discussing the details for brevity. In [2], an advanced method is proposed for tuning of a PID controller in a hydro-turbine for speed and active power control. A PI and also a PR controller for parallel and series inverters in a micro-grid power quality compensator are used in [3] and the gains are tuned analytically based on the concepts of phase and gain margins. Using a PIR for multiple harmonic controls in a

Distributed Generation (DG) unit is proposed in [4]. The frequency injection method for tuning of a PID controller in switch mode power supplies is discussed in [5]. PI and PR controllers are also used and analytically tuned for an inverter-based DG unit [6] and also in a multilevel active filter [7]. In [8], a fuzzy-based self-tuning PI is proposed for a high voltage direct current system. Evolutionary-type algorithms are also used to adjust the controller gains [9]. A PI controller in a static compensator is applied and is designed by means of LQR method in [10]. Model Predictive Control (MPC) is used in [11] to optimize an auto-tuned PID controller for a steam generator. A PR controller tuned based on root-locus method is developed in [12] for a voltage source inverter. Tuning a PID controller using the LQR method for a multivariable system is presented in [13]. A nonlinear control of linearized wind turbine power generation with doubly fed induction generator is optimized by LQR in [14].

To apply LQR method to a regular loop with output feedback, however, the system equations must be put into a state-feedback form. The second limitation is that the LQR addresses a regulation problem and cannot originally be applied to a tracking problem where we are particularly concerned two specific examples of a UPS and a DG system.

The proposed technique of this paper is twofold. The first fold finds an optimal matrix Q (in the LQR formulation) which ensures desired transient response characteristics based on the concept of dominant closed-loop poles. The second approach is based on reformulating the LQR problem such that optimal direct tracking is also addressed.

Structure of the paper is as: Descriptions of a UPS inverter and a DG as case-study systems are provided in Section II. Section III designs optimal feedback controllers for the case-study systems by optimally tuning matrix Q based on the concept of dominant poles. An alternative design approach, which directly addresses the tracking problem, is presented in Section IV and is applied to the UPS and DG unit examples. Realistic simulation results in PSCAD are presented in Section V to verify the analytical results.

II. REVIEW OF UPS AND DG CONTROL SYSTEMS

To develop of proposed optimal tuning method, two specific examples, one in a single phase UPS system and the other one in a dq -transformed three phase grid-connected DG system, as applied to tuning of a PR and a PI controller are considered, successively. In this regard, these two instance systems described briefly in this section.

A. Hasanzadeh and C. S. Edrington (corresponding author) are with The Center of Advanced Power Systems, Florida State University. Email: hasanzadeh@caps.fsu.edu, edrington@caps.fsu.edu. H. Mokhtari is with the Sharif University of Technology. Email: mokhtari@sharif.edu.

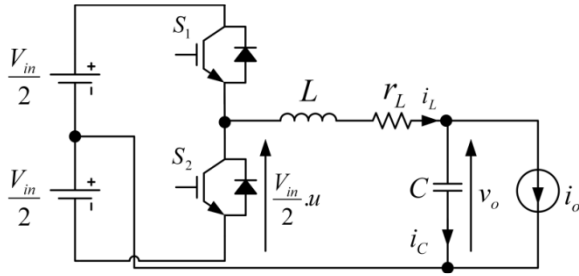

Fig. 1. Power circuit of the single-phase UPS inverter.

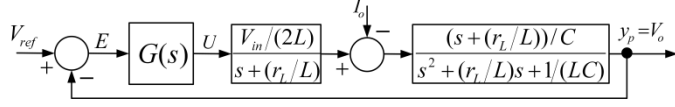

Fig. 2. Block diagram of the UPS inverter control system

A. UPS Inverter System

Figure 1 shows the power stage of a single-phase inverter which includes an IGBT half-bridge configuration and an LC filter. The differential equations that describe the large-signal dynamic behavior of this converter are

$$L \frac{di_L}{dt} = \frac{V_{in}}{2} u - v_o - r_L i_L, \quad i_C = C \frac{dv_o}{dt} = i_L - i_o \quad (1)$$

where u is the discrete control variable which can take values of 1, 0 or -1 depending on the state of switches S_1 and S_2 .

Taking average from (1) over one switching frequency, one can find the state-space equations as:

$$\dot{x}_p = A_p x_p + B_p u + B_w w, \quad y_p = C_p x_p + D_p u$$

where

$$A_p = \begin{bmatrix} 0 & \frac{1}{C} \\ \frac{-1}{L} & \frac{-r_L}{L} \end{bmatrix}, \quad B_p = \begin{bmatrix} 0 \\ \frac{V_{in}}{2L} \end{bmatrix}, \quad x_p = \begin{bmatrix} v_o \\ i_L \end{bmatrix}, \quad y_p = v_o \quad (2)$$

$$C_p = [1 \quad 0], \quad D_p = 0, \quad B_w = \begin{bmatrix} -1 \\ \frac{-1}{C} \end{bmatrix}, \quad w = i_o$$

The control objectives in this system are (1) output voltage regulation which means low RMS steady-state error, (2) fast transient response, and (3) low Total Harmonic Distortion (THD). Note that the command waveform and also the disturbance signal are both sinusoids at the fundamental frequency. Based on the IMP [1], to track a sinusoidal signal, a sinusoidal term must be included in the controller. A so-called PR controller given

$$G(s) = K_1 + \frac{K_2 s + K_3}{s^2 + \omega_o^2} \quad (3)$$

which is thus suitable for the system shown in Fig. 2 where ω_o is the system frequency. Design of controller coefficients of K_1 , K_2 , K_3 to ensure stability and desired optimal performance is the objective.

B. DG System

A DG system works as a power resource through power conditioning ac units such as inverters or ac-ac converters, which can operate either in grid-connected mode as shown in Fig. 3 or in an islanded mode. The output active power P_{DG} and reactive power Q_{DG} from the DG unit to the utility grid should be regulated to reference values P_{ref} and Q_{ref} . The control objectives are pretty much similar to those of the UPS system including low steady-state error, low current

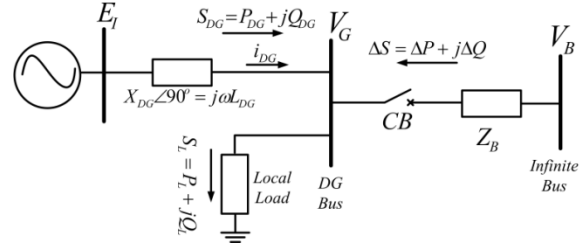

Fig. 3. Single-line diagram of a grid-connected DG system

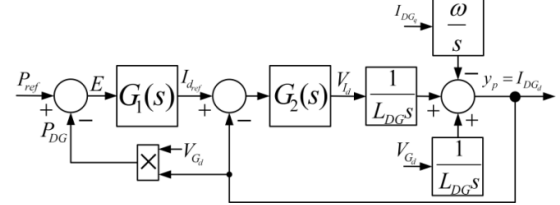

Fig. 4. The d -axis of a DG unit system control block diagram

THD, fast response and also low coupling between P_{DG} and Q_{DG} . Assume that the DG is coupled to the network via an inductance L_{DG} and the resistance is neglected. Note, however, that the presence of this resistance does not increase the model order. Thus, the linear differential equation that describes the large-signal dynamic behavior of this DG unit is

$$L_{DG} \frac{di_{DG}}{dt} = v_l - v_g \quad (4)$$

In a balanced three-phase scenario, the transformation into a synchronous dq frame is defined as

$$f_{dq} = f_d + j f_q = \frac{2}{3} e^{-j\theta} (f_a + e^{j\frac{2\pi}{3}} f_b + e^{j\frac{4\pi}{3}} f_c) \quad (5)$$

where $\theta = \omega_o t + \theta_o$ is the electrical angle of the grid. Then, (4) is transformed into the synchronous reference frame:

$$\frac{di_{DGdq}}{dt} = -j\omega i_{DGdq} + \frac{1}{L_{DG}} (v_{l_{dq}} - v_{g_{dq}}) \quad (6)$$

where $i_{DGdq} = i_{DGd} + j i_{DGq}$ is in the synchronous reference frame. Equivalently, (4-6) with complex variables can be represented by the following matrix equation:

$$\frac{d}{dt} \begin{bmatrix} i_{DGd} \\ i_{DGq} \end{bmatrix} = \begin{bmatrix} 0 & \omega \\ -\omega & 0 \end{bmatrix} \begin{bmatrix} i_{DGd} \\ i_{DGq} \end{bmatrix} + \frac{1}{L_{DG}} \begin{bmatrix} v_{l_d} \\ v_{l_q} \end{bmatrix} - \frac{1}{L_{DG}} \begin{bmatrix} v_{g_d} \\ v_{g_q} \end{bmatrix} \quad (7)$$

It is observed that the state-space equations of the d -axis are $\dot{x}_d = A_d x_d + B_d u_d + B_{w_1} w_1 + B_{w_2} w_2$, $y_d = C_d x_d + D_d u_d$

where

$$A_d = 0 \quad B_d = \frac{1}{L_{DG}} \quad B_{w_1} = \frac{-1}{L_{DG}} \quad B_{w_2} = \omega \quad (8)$$

$$C_d = 1 \quad D_d = 0 \quad w_1 = v_{g_d} \quad w_2 = i_{DGq}$$

$$x_d = y_d = i_{DGd}$$

The output current of the d -axis is thus a function of control signal $u_d = v_{l_d}$, DG bus voltage v_{g_d} and the output current of axis q as indicated by (9) and as shown in Fig. 4

$$i_{DGd}(s) = \frac{1}{L_{DG} s} U_d(s) - \frac{1}{L_{DG} s} V_{g_d}(s) + \frac{\omega}{s} i_{DGq}(s) \quad (9)$$

The grid voltage and q -axis current can be considered as disturbances or can be compensated by a feed-forward path. The q -axis relation is extracted similar to expressions (8-9). All signals in $dq0$ stationary frame have DC characteristics.

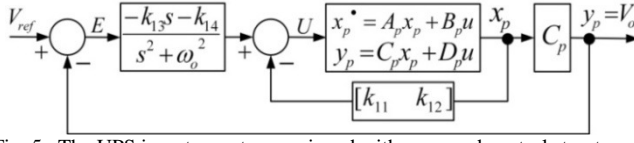

Fig. 5. The UPS inverter system equipped with proposed control structure

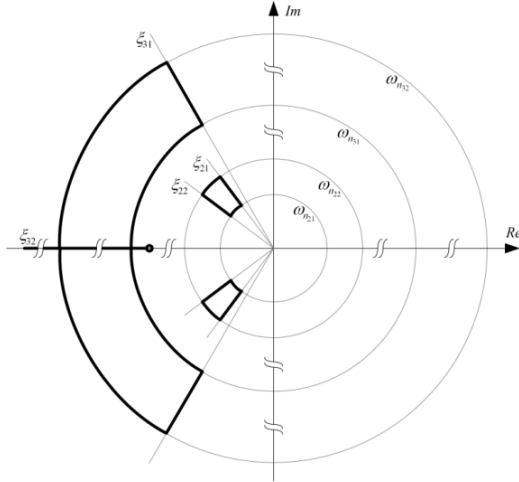

Fig. 6. Desired region for the poles of the UPS control system

Thus, according to IMP, integral-type controllers must be used. The PID structure, with the following expression, is a generally accepted type for this application.

$$G_{V-PID}(s) = K_4 s + \frac{K_5}{s} + K_6 \quad (10)$$

Here again the objective is to design the controller coefficients of K_4 , K_5 and K_6 to achieve stability and desired optimal performance of the DG unit.

III. TUNING OF CONTROLLERS FOR UPS AND DG SYSTEMS

In this section, tuning of a PR controller for a single-phase UPS inverter and a PI controller for a three-phase DG grid-connected inverter are optimally designed using state-feedback law and the LQR concept.

A. UPS Inverter System Control

The UPS output voltage control is performed using the output filter inductor current and the output voltage feedbacks. Since both state variables are available, we rearrange the UPS control system as shown in Fig. 5 into the standard form of an LQR problem. By augmenting the inverter and the R controller variables, the following state-space representation is obtained for the closed-loop control.

$$\dot{x} = Ax + Bu \quad u = -Kx$$

where

$$A = \begin{bmatrix} 0 & \frac{1}{C} & 0 & 0 \\ -\frac{1}{L} & -\frac{r_L}{L} & 0 & 0 \\ -1 & 0 & 0 & -\omega_o^2 \\ 0 & 0 & 1 & 0 \end{bmatrix} \quad B = \begin{bmatrix} 0 \\ \frac{V_{in}}{2L} \\ 0 \\ 0 \end{bmatrix} \quad u = -[k_{11} \quad k_{12} \quad k_{13} \quad k_{14}]x \quad (11)$$

From (11) and by substituting state-feedback law, the closed-loop matrix A_{cl} and thus the closed-loop eigenvalues are obtained from $\det(\lambda I - A_{cl}) = 0$ which is a fourth-order polynomial. Now, we assume a predetermined region for the

TABLE I
PARAMETERS OF THE UPS INVERTER POWER STAGE

$L = 0.8 \text{ mH}$, $r_L = 0.05 \Omega$, $C = 40 \mu\text{F}$, $V_{in} = 208 \text{ V}$, $f_s = 20 \text{ kHz}$, $f_o = 60 \text{ Hz}$, $V_o = 120 \text{ V}_{\text{rms}}$, Load (1 ϕ 1KVA PF = 0.8)

closed-loop eigenvalues which correspond to desired tracking features (see Fig. 6).

$$(\lambda^2 + 2\xi_1\omega_{n1}\lambda + \omega_{n1}^2)(\lambda^2 + 2\xi_2\omega_{n2}\lambda + \omega_{n2}^2) = 0 \quad (12)$$

$$0.6 \leq \xi_1 \leq 0.8 \quad 360 \leq \omega_{n1} \leq 600$$

$$0.5 \leq \xi_2 \leq 2 \quad 1200 \leq \omega_{n2} \leq 24000.$$

This region for parameters is specified based on desired transient response characteristics. The region includes a subregion for two dominant poles characterized by ξ_1 and ω_{n1} which correspond to a desired transient time indicated by a maximum overshoot of 10 percent and a maximum settling time of one cycle of the line frequency (60 Hz). The second subregion characterized by ξ_2 and ω_{n2} simply indicates a non-dominant region for the rest of the poles.

The region as specified by (12) is realized by proper selection of k_{ij} 's and then the reverse procedure in LQR mathematic is started where the k_{ij} 's determine F matrix by using of $K = R^{-1}B^T F$ in LQR concept [15]. Next, the Q matrix is obtained by Algebraic Riccati Equation (ARE) $A^T F + FA + Q - FBR^{-1}B^T F = 0$, where the matrix Q must be non-negative though. This means that the problem does not necessarily have a solution or may not have a solution for the entire assigned gain space K . In fact, this constraint reduces the predefined specified of gain space K . A simple statistical study shows that about 60 percent of the region specified by quadruple $[\xi_1 \quad \omega_{n1} \quad \xi_2 \quad \omega_{n2}]$ corresponds to a non-negative Q and is thus acceptable. There is also another constraint which is imposed by the location of the zero of the R controller. This zero must not be close to the origin nor must it be non-minimum-phase. Enforcing such a constraint will reduce the acceptable range to 40 percent of the specified region. Now, within the entire acceptable range of Q elements, we search for those which satisfy our additional control specifications. Those are output voltage regulation and output voltage low THD. It is now easy to define a cost function which addresses these specifications and arrive at its optimal point using an evolutionary-type algorithm such as Genetic Algorithm (GA) or Particle-Swarm Optimization (PSO). For a single-phase UPS inverter with the power stage parameters given in Table I, we arrive at the values of the optimally design controller coefficients: $k_{11} = 0.0331$, $k_{12} = 0.0589s$, $k_{13} = -27.397s^{-1}$, $k_{14} = -4903s^{-2}$.

B. DG System Control

The same procedure as performed for the UPS system can be applied to the DG unit in $dq0$ stationary frame but only d -axis. The same strategy can be used for the q -axis. Two control loops for d and q axes are considered.

The proposed full-state feedback loop of the system is shown in Fig. 7. This structure composed of an I and a P controller. The P controller uses the state variable of the system (current signal), and the I controller ensures steady-state tracking of the step commands sufficiently. The controllers coefficients are optimally designed in this section. The state-space representation of the system similar

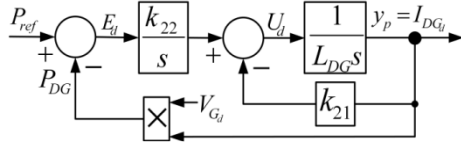

Fig. 7. The DG unit control block diagram with proposed control method

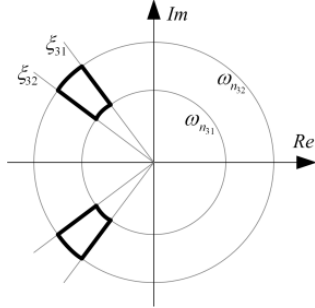

Fig. 8. Desired region for poles of the DG control system

TABLE II
PARAMETERS OF THE DG POWER STAGES

$L = 0.8 \text{ mH}, r_L = 0.05 \Omega, V_{in} = 208 \text{ V}, f_s = 20 \text{ kHz}, f_o = 60 \text{ Hz},$ $V_{oPH} = 120 \text{ V}_{rms}, S_{ref} (3\phi \text{ 3KVA PF} = 0.8)$

to (11) can be shown as

$$A = \begin{bmatrix} 0 & 0 \\ V_{Gd} & 0 \end{bmatrix} \quad B = \begin{bmatrix} 1 \\ L_{DG} \\ 0 \end{bmatrix} \quad u = -[k_{21} \quad k_{22}]x \quad (13)$$

Note that V_{Gd} is the grid voltage and can be assumed constant. The desired solution of vector K coefficients depends on finding the positive semi-definite matrix Q such that appropriate transient response is ensured.

Replacing state-feedback law in $\dot{x} = Ax + Bu$, the closed-loop matrix A_{cl} is derived as $\dot{x} = (A - BK)x = A_{cl}x$ and then the closed-loop eigenvalues λ is obtained

$$\det(\lambda I - A_{cl}) = \lambda^2 + \frac{k_{21}}{L_{DG}}\lambda + \frac{k_{22}V_{Gd}}{L_{DG}} = 0 \quad (14)$$

Equation (14) gives a second order polynomial for P and I controllers' coefficients. Now, by the desired region of Fig. 8 for the closed-loop, poles can be determined

$$\begin{aligned} (\lambda^2 + 2\xi_3\omega_{n3}\lambda + \omega_{n3}^2) &= 0 \\ 0.6 \leq \xi_3 \leq 1 \quad 300 \leq \omega_{n3} \leq 500 \end{aligned} \quad (15)$$

This region is chosen based on the desired specifications of the transient response. The design ensures an overshoot with maximum of 10 percent and a settling time of maximum one cycle of the line frequency. Now, comparing (14) with (15), k_{ij} can be found as $k_{21} = 2\xi_3\omega_{n3}L_{DG}$ and $k_{22} = \frac{\omega_{n3}^2 L_{DG}}{V_{Gd}}$. Then,

the corresponding elements of the matrix F are obtained by substituting k_{ij} into $K = R^{-1}B^T F$ of LQR concept. Finally, the q_{ii} elements of matrix Q are achieved by substituting f_{ij} into ARE as :

$$\begin{aligned} q_{11} &= 2(2\xi_3^2 - 1)\omega_{n3}^2 L_{DG}^2 & q_{11} &\geq 0 \quad \text{if} \quad \xi_3 \geq \sqrt{2}/2 \\ q_{22} &= \omega_{n3}^4 L_{DG}^2 / V_{Gd}^2 & q_{22} &\geq 0 \end{aligned} \quad (16)$$

It can be observed that for the matrix Q to be non-negative the condition $\xi_3 \geq \sqrt{2}/2$ must hold. Any selection in this set results in an optimum operation of the system performance. Now, one can find those which satisfy further control specifications such as the output current THD. This can be done using a fitness function and by means GA. The DG unit parameters are given in Table II. Applying the proposed

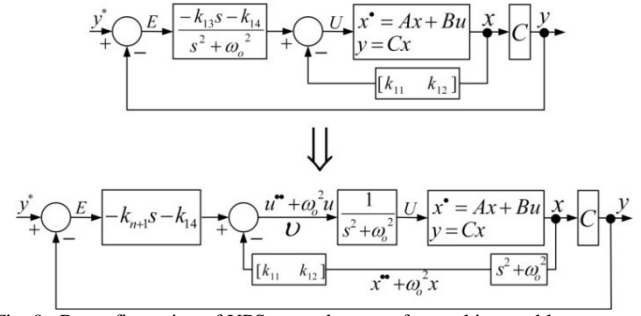

Fig. 9. Reconfiguration of UPS control system for tracking problem

procedure to the control parameters results in $k_{21} = 0.5657$, $k_{22} = 0.6428s^{-1}$.

IV. ALTERNATIVE DESIGN OF CONTROLLERS BASED ON OPTIMAL TRACKING

The previous design strategy discussed in Section IV is based on placing the closed-loop poles in a suitable region in the complex plane to ensure desired transient response. In other words, the LQR which can only solve a "regulation" problem is indirectly used to ensure desired "tracking" features. The tracking problem can generally be put in the following framework. Assume that y^* is the command signal and y is the output signal. Moreover, assume that u is the control signal and u^* is a desired control signal at steady-state (it is not known and even if it is known, it has uncertainties) which generates y^* . This tracking-based design method derive the controller u such that the following index is minimized

$$J(u) = \int_0^{\infty} (h(y^* - y)^2 + (u^* - u)^2) dt \quad (17)$$

where h is the weight of the tracking term in fitness function. Now, we address this problem for a UPS and a DG system.

A. Rearrangement of the UPS System Model

In the case of the UPS inverter system, the command signal y^* is a pure sinusoidal signal at frequency ω_o . This means that all signals will be sinusoids at frequency ω_o at steady-state. Thus, they (including y^* , y and u) all satisfy the equation:

$$v = \ddot{u} + \omega_o^2 u = 0 \quad (18)$$

During the transient-time, however, this equation is not heeded. Thus, v in (18) is an index of how far the signal is from the desired value at time instant t . We, thus, modify the index function (17) as $J(u) = \int_0^{\infty} (he^2 + v^2) dt$.

Now, to formulate a solution to this problem, consider the IMP-based model with sinusoidal input reference as reconfigured in Fig. 9. It is convenient to redefine the state variables in this system in order to transform the tracking problem into a regulation problem as follows.

$$\dot{\bar{X}} = \bar{A}\bar{X} + \bar{B}v \quad v = -\bar{K}\bar{X}$$

where

$$\begin{aligned} \bar{A} &= \begin{bmatrix} A & 0 & 0 \\ -C & 0 & -\omega_o^2 \\ 0 & 1 & 0 \end{bmatrix}, \bar{B} = \begin{bmatrix} B \\ 0 \\ 0 \end{bmatrix} & \bar{X} &= \begin{bmatrix} \dot{x} + \omega_o^2 x \\ \dot{e} \\ e \end{bmatrix} \\ \bar{K} &= -[k_1 \quad \dots \quad k_n \quad k_{n+1} \quad k_{n+2}] & v &= \ddot{u} + \omega_o^2 u \end{aligned} \quad (19)$$

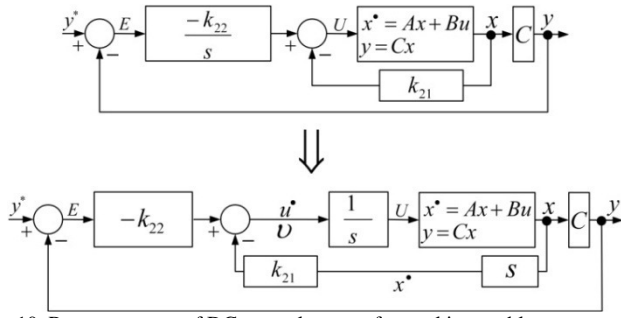

Fig. 10. Rearrangement of DG control system for tracking problem

Now, the index function can be rewritten as

$$J(u) = \int_0^{\infty} (he^2 + v^2) dt = \int_0^{\infty} (\bar{X}^T Q_1 \bar{X} + v^2) dt \quad (20)$$

where $Q_1 = \begin{bmatrix} 0 & 0 & 0 & 0 \\ 0 & 0 & 0 & 0 \\ 0 & 0 & 0 & 0 \\ 0 & 0 & 0 & h \end{bmatrix}$

This means that the tracking problem has been transformed into a regulation problem and Q_1 matrix can optimally be addressed. The proposed technique is applied to the UPS inverter with the power stage specification of Table I. The control parameters of $k_{11} = 0.00436$, $k_{12} = 0.02116 s$, $k_{13} = -31.354 s^{-1}$, $k_{14} = -70021 s^{-2}$ are obtained for a value of $h = 5 \times 10^9$.

B. Rearrangement of the DG Unit Model

The optimal tracking problem in the DG unit can be expressed as follows. Obtain the controller coefficients such that the following function is minimized

$$J(u) = \int_0^{\infty} (h(r - Cx)^2 + \dot{u}^2) dt = \int_0^{\infty} (he^2 + v^2) dt \quad (21)$$

Note that in (21), we have considered the fact that the signals are DC and the derivative is an index for the error. The state-space model of the system is rearranged Fig. 10. With this configuration, the state variables are redefined and the new matrices are

$$\dot{\bar{X}} = \bar{A}\bar{X} + \bar{B}v \quad v = -\bar{K}\bar{X}$$

where

$$\begin{aligned} \bar{A} &= \begin{bmatrix} A & 0 \\ -C & 0 \end{bmatrix} & \bar{X} &= \begin{bmatrix} \dot{x} \\ e \end{bmatrix} & v &= \dot{u} \\ \bar{B} &= \begin{bmatrix} B \\ 0 \end{bmatrix} & \bar{K} &= -[k_{21} \quad k_{22}] \end{aligned} \quad (22)$$

Now, similar to UPS system with index function of (20), the corresponding Q_1 matrix can be found as $Q_1 = \begin{bmatrix} 0 & 0 \\ 0 & h \end{bmatrix}$. By using this Q matrix, the tracking problem is transformed into a regulation problem which can be solved using LQR method. The proposed design technique is applied to a DG unit with power stage parameters of Table II. The resulted control parameters are $k_{21} = 0.8459$, $k_{22} = -1.4374s^{-1}$ for a value of $h = 2.066$.

V. SIMULATION RESULTS

To verify performances of the proposed controllers in a realistic scenario, the UPS and DG systems are simulated within the EMTDC/PSCAD [16] environment. The controllers' gains are tuned using the proposed algorithms. Results are summarized as follows.

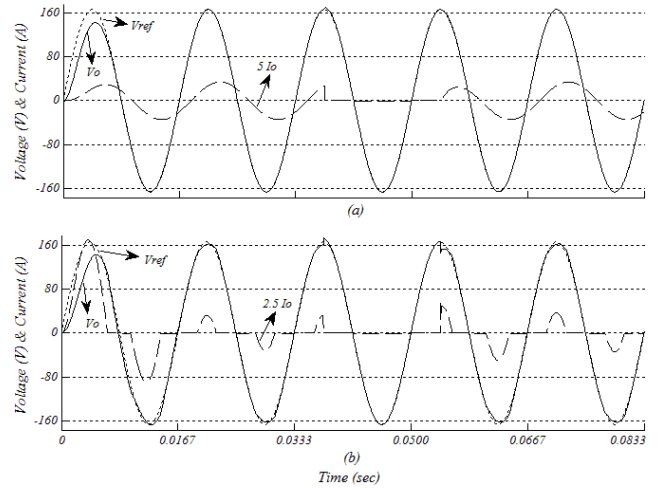

Fig. 11. Simulation results of UPS inverter with proposed LQR controller design which supplies (a) a linear load (b) a non-linear load

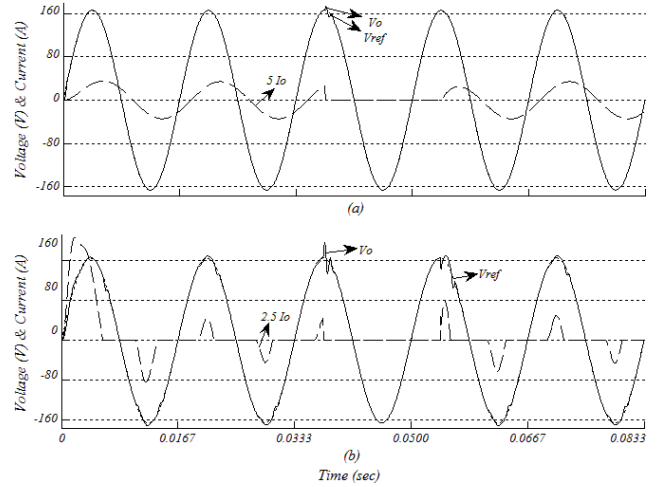

Fig. 12. Simulation results of UPS inverter with proposed tracking controller design which supplies (a) a linear load (b) a non-linear load

A. UPS System

A half-bridge UPS inverter with an output $L - C$ filter is simulated with power and control stages parameters stated in Sections III.A and IV. A for regulation and tracking problems by supplying both linear and nonlinear loads which are compliant with IEC 62040-3 standard for class-I UPS.

The output voltage has a low THD with zero steady-state error in the RMS. In addition, Fig. 11 shows the reference voltage, output voltage and current signals for both linear and non-linear loads when the first LQR-based technique is used to tune the controller gains. Fig.12 presents similar results when the proposed tracking-based controller is used. Both figures confirm a desired transient response of the closed-loop system.

B. DG Unit

A three-phase three-leg inverter-based DG unit is connected to an infinite bus by an inductor. This system is simulated in PSCAD with the power and control stages parameters stated in Section III.B and IV.B. Figure 13 shows the transient response of the closed-loop system to a real-power command when the LQR-based controller is in

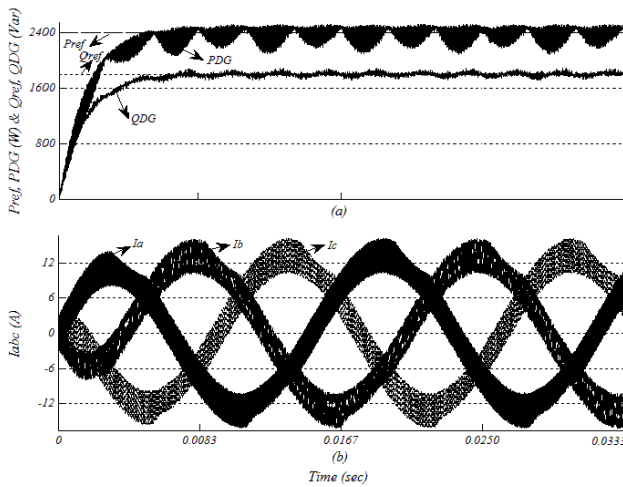

Fig. 13. Simulation results of DG unit with proposed LQR-based controller (a) output power (b) output current

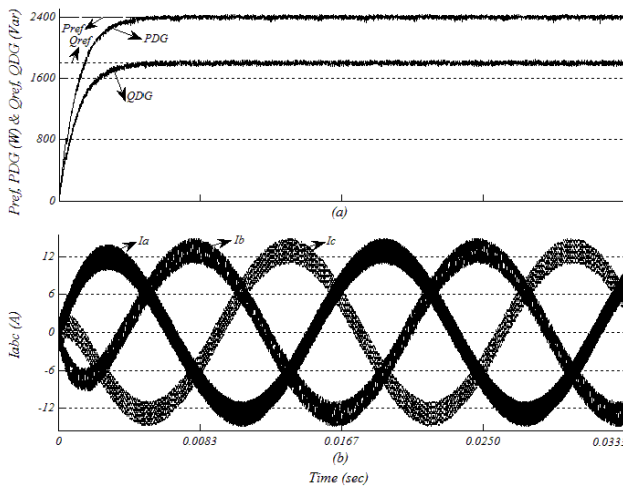

Fig. 14. Simulation results of proposed tracking-based DG unit controller (a) output power (b) output current

operation. Figure 14 shows similar results when the tracking-based controller is used. Both methods offer desirable transient and steady-state performances while the tracking-based controller exhibits some improved smoothness of the signals which results in considerable reduction of the current THD. This can be explained using the fact that the tracking controller aims at minimizing the tracking error directly while the LQR controller does this in an indirect manner without particular emphasis on the tracking error.

VI. CONCLUSION

The LQR technique is a well-known method used for optimal tuning of controllers which can only address a state-feedback controller used in the context of a regulation problem. In practice, it is often necessary to use an output-feedback controller instead and a tracking problem is the objective to be attained. In first proposed method of this paper, the regulation problem is finally addressed using the LQR method. Next, a new tracking-based method tunes controller parameters to directly achieve well output tracking. The matrix Q is then determined to properly place the closed-loop poles in order to achieve desired transient

response. Both methods are examined on a UPS inverter and a DG control systems. The controllers are designed and the overall systems are simulated in PSCAD. Desired performances of the proposed controllers are observed from the simulations.

ACKNOWLEDGMENT

The authors would like to thank Dr. M. Karimi Ghartemani of Sharif University of Technology, Tehran, Iran, for his valuable discussion. Additionally, we would like to thank the Florida State University's Institute for Energy Sustainability and Economic Studies for funding the effort.

REFERENCES

- [1] B. A. Francis and W. M. Wonham, "The internal model principle of control theory," *Automatica*, vol. 12, pp. 457–465, 1976.
- [2] B. Strah, O. Kuljaca and Z. Vukic, "Speed and Active Power Control of Hydro Turbine Unit," *IEEE Trans. Energy Convers.*, vol. 20, no. 2, pp. 424–434, June 2005.
- [3] Y. W. Li, D. M. Vilathgamuwa and P. C. Loh, "A Grid-Interfacing Power Quality Compensator for Three-Phase Three-Wire Microgrid Applications," *IEEE Trans. power Electron.*, vol. 21, no. 4, pp. 1021–1031, July 2006.
- [4] M. Liserre, R. Teodorescu and F. Blaabjerg, "Multiple Harmonics Control for Three-Phase Grid Converter Systems With the Use of PI-RES Current Controller in a Rotating Frame," *IEEE Trans. power Electron.*, vol. 21, no. 3, pp. 836–841, May 2006.
- [5] L. Corradini, P. Mattavelli, W. Stefanutti and S. Saggini, "Simplified Model Reference-Based Autotuning for Digitally Controlled SMPS," *IEEE Trans. power Electron.*, vol. 23, no. 4, pp. 1956–1963, July 2008.
- [6] Y. W. Li, "Control and Resonance Damping of Voltage Source and Current Source Converters with LC Filters," *IEEE Trans. Ind. Electron.*, *Accepted for future publication*, Oct. 2008.
- [7] A. Dell'Aquila, M. Liserre, V. G. Monopoli and P. Rotondo, "Overview of PI-Based Solutions for the Control of DC Buses of a Single-Phase H-Bridge Multilevel Active Rectifier," *IEEE Trans. Ind. Appl.*, vol. 44, no. 3, pp. 857–866, May/June 2008.
- [8] A. Routray, P. K. Dash and S. K. Panda, "A Fuzzy Self-Tuning PI Controller for HVDC Links," *IEEE Trans. power Electron.*, vol. 11, no. 5, pp. 669–679, Sep. 1996.
- [9] M. Zamani, N. Sadati and M. Karimi-Ghartemani, "Design of an ∞ PID Controller Using Particle Swarm Optimization," *accepted for publication in International Journal of Control, Automation and Systems*, September 2008.
- [10] P. Rao, M. L. Crow and Z. Yang, "STATCOM Control for Power System Voltage Control Applications," *IEEE Trans. power Electron.*, vol. 15, no. 4, pp. 1311–1317, Oct. 2000.
- [11] M. G. Na, "Auto-Tuned PID Controller Using a Model Predictive Control Method for the Steam Generator Water Level," *IEEE Trans. power Electron.*, vol. 48, no. 5, pp. 1664–1671, Oct. 2001.
- [12] E. Twining and D. G. Holmes, "Grid Current Regulation of a Three-Phase Voltage Source Inverter With an LCL Input Filter," *IEEE Trans. power Electron.*, vol. 18, no. 3, pp. 888–895, May 2003.
- [13] Y. Zhang, L. S. Shieh and A.C. Dunn, "PID controller design for disturbed multivariable systems," *IEE Proc. Control Theory Appl.*, vol. 151, no. 5, pp. 567–576, Sep. 2004.
- [14] F. Wu, X. P. Zhang, P. Ju and M. J. H. Sterling, "Decentralized Nonlinear Control of Wind Turbine with Doubly Fed Induction Generator," *IEEE Trans. power Syst.*, vol. 23, no. 2, pp. 613–621, May 2008.
- [15] B. D. O. Anderson and J. B. Moore, *Linear Optimal Control*. Englewood Cliffs, NJ: Prentice-Hall, 1971.
- [16] Developed by Manitoba research Centre Inc. V4.0.1(Apr. 11 2003)