

Evaluating the Benefits of a Hybrid Solid Oxide Fuel Cell Combined Heat and Power Plant for Energy Sustainability and Emissions Avoidance

C. M. Colson, *Student Member, IEEE*, and M. H. Nehrir, *Fellow, IEEE*

Abstract—Recent developments in solid oxide fuel cell (SOFC) technology have increased interest in their application toward distributed electricity generation. In addition to the demonstrated SOFC fuel-to-electricity conversion advantages over conventional generation methods, heat from SOFC exhaust can be recovered for combined heat and power (CHP) operations to improve overall system efficiency. This paper presents a system model, developed using MATLAB/Simulink, for a 1.0-MW SOFC-CHP power plant and evaluates its ability to provide electricity and hot water to a 500-home residential neighborhood more sustainably and avoiding substantial environmental emissions when compared to conventional power delivery. Actual residential electrical and hot water end-usage profiles are utilized for simulations of the SOFC-CHP plant operating interconnected with the utility power system. Results are compared to data from conventional electricity regional suppliers in the United States. The simulation findings indicate the suitability of SOFC technology with CHP for distributed generation applications, highlight unique benefits of CHP operations for the residential case, and show the functional value of SOFC-CHP technology in the broader context of energy sustainability goals while significantly reducing emissions.

Index Terms—Combined heat and power (CHP), electricity generation, energy sustainability, solid oxide fuel cells (SOFCs).

I. INTRODUCTION

CONCERNS about environmental emissions from centralized power plants and the uncertainty of global energy supplies have increased interest in fuel cell technologies for small- to large-scale electricity generation [1], [2]. Solid oxide fuel cells (SOFCs) are direct electrochemical energy-conversion devices that commute the chemical energy of a fuel-oxygen reaction to electrical energy at higher efficiency (45%–65%) compared to conventional electricity generation using a combustion process [3]–[5]. In the United States, the average power plant conversion efficiency is 33.2% [6], with typical coal and natural

gas combustion power plants operating at 20%–38% and 30%–50% efficiency, respectively [7]–[9]. In addition, SOFCs operate at high temperatures, typically 600–1000 °C, which facilitates internal fuel reforming. This makes SOFCs very attractive because they can utilize a range of fuels including gaseous hydrogen, natural gas, and products of coal gasification. Furthermore, hot exhaust streams can be harnessed for combined cycle (CC) or combined heat and power (CHP) operations that convert or transfer additional energy rather than reject it to the environment. SOFCs operating in hybrid mode with CHP systems can raise overall system efficiency to about 80% [10].

SOFC technology, coupled with CC/CHP systems, may provide a viable solution for improving generation efficiencies to meet the world's growing electricity needs with less environmental impact. Improved fuel-to-electricity efficiency implies that a smaller portion of fuel is required to generate equivalent quantities of electrical energy, and less fossil fuel consumed translates into reduced emissions. In this way, SOFCs alone can be seen as a transitional technology for achieving energy sustainability. Although a hydrogen supply infrastructure does not currently exist for widespread electricity generation, SOFCs promise higher fuel-conversion efficiencies even when capitalizing on existing supplies of a relatively clean fossil fuel such as natural gas. In this regard, the benefits of reduced emissions, including less CO₂ produced per kilowatt-hour of electrical energy generated, are immediate. However, in the future, their inherent fuel flexibility allows SOFCs to rapidly shift to hydrogen, a zero-emissions fuel source, when supplies become more available. In similar ways, capitalizing on waste heat to offset energy consumption further enhances the value of SOFC-CHP within a sustainable generation portfolio. These observations and recent research have demonstrated SOFC-CHP potential for large-scale power production [11].

This paper seeks to address practical applications of SOFCs by evaluating their potential for electric power and hot water production, and consequently, emissions reduction. It is a follow-on paper to previous work reported by the authors on the development and validation of a physically based dynamic model for SOFC [12], [13], SOFC efficiency evaluation in CC mode [14], and the development of a large-scale SOFC power plant model [15]. Specifically, the paper evaluates the benefits of a 1.0-MW SOFC-CHP plant for sourcing electrical power and hot water to a residential neighborhood more sustainably and avoiding significant emissions when compared to conventional (typically coal generated) electricity. Although important, the present high capital costs of SOFCs as well as the absence of

Manuscript received February 4, 2010; revised July 15, 2010; accepted August 13, 2010. Date of publication October 4, 2010; date of current version February 18, 2011. This work was supported in part by the National Science Foundation Graduate Research Fellowship Program, and in part by the HiTEC Fuel Cell Project at Montana State University, funded by the U.S. Department of Energy, as a subcontract from Battelle Memorial Institute and Pacific Northwest National Laboratory under Award No. DE-AC06-76RL01830. Paper no. TEC-00056-2010.

The authors are with the Department of Electrical and Computer Engineering, Montana State University, MT 59717 USA (e-mail: christopher.colson@msu.montana.edu; hnehrrir@ece.montana.edu).

Color versions of one or more of the figures in this paper are available online at <http://ieeexplore.ieee.org>.

Digital Object Identifier 10.1109/TEC.2010.2070506

carbon production costs in the United States are not considered in this paper. The focus, therefore, is not on the expense of implementing a SOFC–CHP power plant, but instead on the practical benefits of operating such a system. Simply put: SOFC technology will not experience market acceptance until capital costs drop and the benefits of SOFCs over other technologies (in terms of efficiency, reliability, ease of use, robustness, scalability, etc.) are demonstrated. Apart from this important consideration, this paper attempts to present a forward-looking analysis by showing an innovative means for offsetting conventional electricity production and deriving an ancillary commodity (e.g., hot water) in a way that is not only more efficient, but also yields interesting benefits for both the customer and the power system. It is hoped that this practical discussion of SOFC–CHP technology will aid in its acceptance and broadened applicability.

The remainder of this paper is organized as follows. A proposed SOFC–CHP power plant system that incorporates a power electronic interface for grid-interconnected operation is discussed in Section II. Real-world, data-based load profiles are given in Section III. Methodology and simulation studies are given in Section IV, and an examination of on-peak demand reduction and emissions avoidance are presented in Section V. Finally, conclusion is given in Section VI.

II. POWER PLANT CONFIGURATION

A. SOFC Stack

The physically based dynamic model for a 5.0-kW tubular SOFC stack, reported in [12] and [13], has been used for simulating the power sources comprising the 1.0-MW power plant. The model was developed based on SOFC thermodynamic, electrochemical, and material diffusion properties, and the mass and energy conservation laws, with emphasis on the fuel cell electrical terminal quantities. The model input quantities are anode and cathode pressures, hydrogen flow rate, water vapor flow rate, dry air flow rate, and initial fuel cell and air temperatures. The model output quantities are the fuel cell voltage and internal temperature. Each stack is comprised of 96 individual fuel cells that combine to yield useful electrical power. At any given load current and time, cell temperature is determined and fed back, along with a current signal, for computation of SOFC output dc voltage. The result is a robust SOFC model that can be simulated in a variety of scenarios showing detailed dynamic changes in stack conditions. Detailed information about the SOFC model is given in [12] and [13].

The voltage versus current and the power versus current characteristics for the 5-kW SOFC stack are shown in Fig. 1. The figure shows that as the stack becomes more electrically loaded, its terminal output voltage decreases. This is due to a number of factors described in [12] and [13]. Power output from the SOFC stack is greatest near the bottom of the operating voltage range, but at higher operating currents.

B. SOFC Power Plant and Grid Interconnection

Power modules comprising interconnected 5.0-kW SOFC stacks are combined to achieve larger power capacities. In this

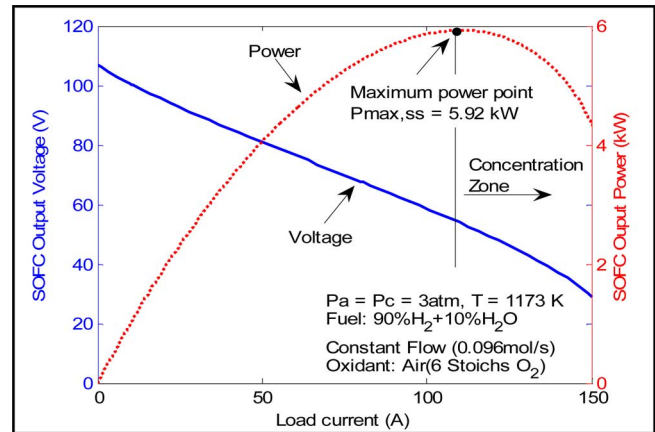

Fig. 1. SOFC dynamic output voltage and power characteristics [14].

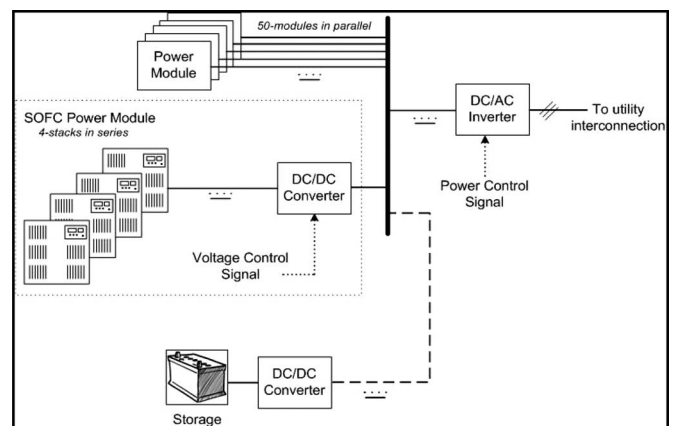

Fig. 2. System-level diagram of the 1.0-MW SOFC power plant.

case, it is desirable for each SOFC stack to operate near the maximum power point (MPP), shown in Fig. 1. The MPP for the SOFC stack is roughly 108 A at 55 Vdc.

Taking the nominal stack current of 100 A, a 20-kW power module with a nominal output voltage of 220 Vdc is formed by connecting four SOFC stacks in series, as shown in Fig. 2. Each power module is connected to a common dc bus through individual boost dc/dc converters based on a 5.0-kHz switching frequency for insulated gate bipolar transistor (IGBT) electronic switches. The dc/dc converters adapt the combined fuel cell module output voltage to a relatively constant dc bus voltage (480 V). A total of 50 SOFC power modules are utilized to achieve nominal power plant capacities of 1.0 MW, as shown in Fig. 2. Additional detail on model development is contained in [13] and details regarding the system configuration and development, shown in Fig. 2, can be found in [15].

Through simulation, it was shown that additional SOFC power modules improved the plant's margin when responding to large transients. Not only did total plant capacitance rise from added power modules, but when the plant experienced large up-power transients, the effect was spread over more stacks. By dispersing transients over a larger field of stacks, large and rapid changes to fuel and oxidizer flows were reduced. The ultimate effect of adding SOFC plant power modules was to boost the

margin between nominal and rated operating conditions; and, this improved overall plant performance, which could extend SOFC useful lifespan. It is noted that, although rated for a nominal 1.0-MW capacity, the peak capacity of 50 SOFC power modules is 1.188 MW [15].

The common dc bus feeds a three-arm dc/ac inverter to achieve three-phase ac electrical power. The inverter pulse width modulation (PWM) control signal with a 4860-Hz carrier frequency is provided by a $V-I$ controller discussed shortly. It is assumed that the 1.0-MW SOFC power plant encompasses the SOFC stacks, dc/dc converters, dc/ac inverter, and control and instrumentation circuitry. Exterior to the power plant are filtering and capacitive compensation components, a transformer, and a short-run distribution line, consistent with utility interconnection. Power from the inverter is filtered, transformed to utility-grade (12.5 kV) voltage, and is transmitted through a short distribution line to the utility grid. The power plant was designed and simulated without battery storage, but it is a noted future possibility, shown by dashed lines in Fig. 2. Power plant grid interconnection configuration and parameters are given in [15].

C. Power Electronic Control and Power Management

The SOFC-CHP plant must employ a power management controller to properly sustain the electrical loads attached to the local grid. Power management is achieved by controlling the PWM duty cycle and modulation index signal that operates the inverter. By controlling the inverter, its output voltage amplitude, angle, and frequency are manipulated as load demand changes, and resultantly, the real and reactive power flows from the power plant to the load adjust accordingly. The power electronics interface employed commands the power plant to match reference values after a disturbance. Details about how the power management controller senses changes in load demand and manipulates SOFC plant output to meet the demand are given in [13].

For the purpose of this study, the SOFC-CHP plant was operated interconnected with a utility grid. Although utility power was available to the local grid, this study focused on the ability of the SOFC-CHP power plant to meet the power and hot water demands of the 500-residence case study without requiring support from the utility. As with most generation sources, SOFCs have a region of operation that yields the highest conversion efficiency from fuel-to-electrical energy. In future work, the economic advantage of operating the SOFC-CHP plant continuously at or near its most efficient operating point and providing excess real/reactive power to the utility will be explored. The obvious advantage of this alternative is to minimize transients on the SOFC-CHP plant, but the clear disadvantages are frequent power reversals across the point of common coupling (PCC). In a dynamic pricing environment where conventional and ancillary power economics can be utilized for dispatch decisions, the opportunity to apply power management optimization to SOFC-CHP plant control may exist. For example, when economically advantageous, the SOFC-CHP plant could provide voltage support by supplying reactive power to a weak radial

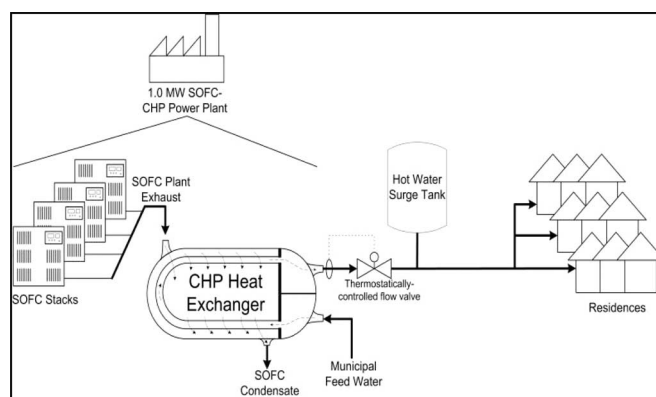

Fig. 3. CHP system configuration for 1.0-MW SOFC-CHP power plant.

feeder, or contribute real power for export. These analyses are meant to preface future study by the authors.

D. CHP System for Residential Hot Water Production

The schematic of the SOFC-CHP system used in this study is shown in Fig. 3. The hot, gaseous exhausts from each SOFC plant stack are aggregated into a common exhaust header. This exhaust passes through a conventional cross-flow, shell-and-tube heat exchanger. In this study, the heat-exchanger arrangement used takes advantage of unique SOFC exhaust characteristics. In conventional steam exhaust CC applications, exhaust used for work extraction is often at high temperature and pressure. This is not the case for SOFC applications. SOFC exhaust is at relatively high temperature under normal operating conditions (600–1000 °C), but its pressure is near atmospheric. This complicates work-extraction techniques such as in a turbine, but is suitable for heat transfer operations in a heat exchanger. Thus, for the purpose of this study, hot exhaust streams resulting from SOFC operations are utilized in a CHP system for the production of residential hot water.

The high-temperature exhaust stream passes through the heat-exchanger shell and transfers heat to the cooler inner tubing containing the residential hot water, thereby heating it to specified temperatures. Feed water for the residential hot water is supplied to the cold inlet of the heat exchanger from the municipal water supply. It is assumed that the municipal feed water is supplied by underground piping and at a constant 13 °C (about 55 °F). The feed water is circulated around the u-shaped inner tubing of the exchanger by the pressure maintained by the water utility (between 40 and 80 psi), thereby eliminating the need for local booster pumps. After the SOFC exhaust passes through the heat-exchanger transferring heat to the residential hot water, it is expelled to the environment at 200 °C. This value ensures an adequate margin above the saturation temperature (vaporization point) for water contained in SOFC exhaust and prevents pressure fluctuations inside the heat exchanger due to significant condensation.

In order to ensure a constant 50 °C (about 122 °F) hot water supply to the residences, two fluid-system arrangements were considered. The first method, although not used for this study, is the more traditional method for producing hot water at desired

temperatures by the use of a cold water mixing valve. In this arrangement, as SOFC exhaust heat varies, the quantity of heat transferred in the exchanger varies, but feed-water flow through the heat exchanger depends solely on residential demand at the time. As a result, the feed water may become too hot (or too cold) for residential delivery, because of the competing factors: residential hot water demand and SOFC exhaust heat flow. Given these factors, hot water within proper temperature limits must be delivered to the residential customer and is done so by mixing the variable temperature hot water with cooler feed water prior to entering the home. The drawbacks of this arrangement are complexity, inefficiency, and potential periods when residential demand exceeds the heating capability of the SOFC-CHP system.

The alternative fluid-system arrangement, used in this study, is simpler and is shown in Fig. 3. In this fluid system, a thermostatically controlled flow valve varies the flow rate of feed water through the heat exchanger. The flow valve controller senses water temperature at the outlet of the heat exchanger and commands valve position, thereby controlling feed-water flow. In this manner, the flow valve operates independent of residential hot water demand, at all times maintaining the customer's water temperature at a constant 50 °C. Therefore, if more SOFC exhaust heat is available, the flow valve opens to raise feed-water flow rate. If this increased flow is not demanded by residential customers at the time, excess hot water fills the insulated surge tank. As SOFC exhaust heat drops, the flow valve throttles less feed water through the heat exchanger. Correspondingly, if instantaneous demand is higher than the output of the heat exchanger, the surge tank is drawn down. Key to this system arrangement is an appropriately sized surge tank and heat exchanger to ensure hot water sustainability. In this study, the heat exchanger was designed according to SOFC exhaust parameters [14]. The surge tank volume was set at 17000 gal, a size reasonable for installation in a residential neighborhood, which is roughly the volumetric capacity of two 18-wheel tanker trucks.

The thermodynamics of the CHP system are described by (1)–(3) [16]. This system arrangement eliminates the possibility of boiling feed water inside the heat exchanger by constantly monitoring hot water outlet temperature and adjusting feed flow rate accordingly

$$\Delta\dot{Q}_H = \Delta\dot{Q}_C \quad (1)$$

$$A(T_{\text{outlet}} - T_{\text{condensate}}) = \dot{m}_{\text{feed}} \cdot c_{p,\text{HW}}(T_{\text{HW}} - T_{\text{feed}}) \quad (2)$$

$$A = \dot{m}_{\text{SOFC exhaust}} \cdot c_{p,\text{exhaust}} = \sum_{\text{exhaust components}} \dot{m}_i \cdot c_{p,i} \quad (3)$$

where, $\Delta\dot{Q}_H$ is the SOFC exhaust process heat transfer rate, $\Delta\dot{Q}_C$ is the residential hot water (HW) process heat transfer rate, A is the sum of the mass flow rates (\dot{m}_i) for each SOFC exhaust stream constituent, times the corresponding specific heat capacity ($c_{p,i}$), T_{outlet} is the uniform exhaust temperature, $T_{\text{condensate}}$ is the uniform condenser exhaust temperature, \dot{m}_{feed} is the feed flow rate controlled by the flow valve, $c_{p,\text{HW}}$ is the municipal supply feed-water specific heat capacity, T_{HW} is the

heat-exchanger hot water outlet temperature set point (60 °C, see the following), and T_{feed} is the feed-water temperature. When supplied by atmospheric air and hydrogen fuel, SOFC exhaust gases are: water; oxygen; nitrogen; and unconverted hydrogen.

For this CHP system, three primary parameters (SOFC exhaust mass flow rate, exhaust temperature, and feed-water flow rate) vary, but must remain thermodynamically balanced. As residential hot water demand varies with use patterns, the surge tank level changes based on the difference between feed-water flow rate and demand, shown as follows:

$$\dot{m}_{\text{surge tank}} = \dot{m}_{\text{residential HW}} - \dot{m}_{\text{feed}} \quad (4)$$

$$l_{\text{surge tank}} = l_{\text{nominal}} + L_c \int_{t_0}^{t_f} \dot{m}_{\text{surge tank}} \quad (5)$$

where, $\dot{m}_{\text{residential HW}}$ is the mass flow rate of residential hot water demand, $\dot{m}_{\text{surge tank}}$ is flow rate out of or into the surge tank (positive value is flow out, negative if flow in), $l_{\text{surge tank}}$ is surge tank water level, l_{nominal} is surge tank initial level, L_c is a conversion factor from mass of water to a proportional volumetric quantity within the surge tank, and t_f and t_0 represent the time values for integration.

It is noted that three primary mechanisms of heat transfer to the environment are considered for CHP system design. First, based on shell and tube design, heat is inevitably lost through the heat-exchanger shell. This heat conduction to the ambient air surrounding the exchanger surface is modeled with traditional Newton's cooling laws [16]. Second, hot water energy is transferred as heat to supply piping, the surge tank wall, and components that link the SOFC-CHP plant to the residences. This heat loss, primarily by radiative and conductive means, is modeled as 15% of the energy content of the hot water supply. Additionally, heat loss that numerous homes in the United States experience through noninsulated hot water distribution piping is accounted for by simulating as much as a 10 °C (18 °F) temperature drop from where supply piping enters an individual residence and the hot water point-of-use. Correspondingly, the supply temperature set point, based on temperature sensed by the thermostatic flow control valve at the heat-exchanger outlet, is set at 60 °C (140 °F).

E. Additional Balance of Plant Considerations

The SOFC-CHP plant requires secondary subsystems to maintain its proper operation, as described in [14]. These systems include reagent preheating, compressor operations, fuel processing, etc. Typically, the comprehensive analysis of these total system operations is referred to as balance of plant (BOP). While particular designs are not covered in this paper, preconditioning subsystems needed to operate the SOFC stacks are dynamically modeled in parallel with CHP analysis. Heat transfer required to conduct preheating and fuel conditioning for anode reagents, as suggested by [17] and [18], is derived from regenerative heat exchange using a portion of exhaust gases. Although not a true CHP process, by feeding back some exhaust heat to prepare anode reagents for electrochemical conversion in the SOFC stack, significant energy is retained within the system. Regenerative heating significantly improves overall system

efficiency and must be considered in total SOFC–CHP system BOP analysis. Similarly, atmospheric air applied to the cathode is regeneratively preheated. Although, some SOFC systems allow cathode reagents at ambient temperatures to be warmed internally within the SOFC [17], in this simulation study, supply air is heated to approximately 400 °C prior to use in the SOFC stack, thereby limiting electrochemical performance degradation and avoiding significant thermal shock.

III. LOAD-PROFILE DATA SETS

A key aspect of this case study involved the use of detailed residential sector load-profile information to simulate the proposed SOFC–CHP system under real-world conditions. Non-proprietary or publicly available end-use electrical system information for the United States is not readily available and difficult to acquire. Recently, some studies, including those involving distributed generation (DG), have demonstrated a need for accurate time-based load information for the residential case. Possibly because of the difficulty obtaining good data sets, recent studies have attempted to specifically model residential load composition rather than obtain data from actual monitoring [19]–[21]. Another technique involves aggregating medium- and low-voltage (MV/LV) load models for simulating blended commercial, residential, and industrial load connected to a particular substation. Often aggregate data is more easily obtained from detailed consumption information maintained by electrical utilities through billing. Unfortunately, when precise residential end-use data is desired, it is typically calculated as a percentage of the total aggregated load [22]. Instead, for this study, an alternative method for accurate and relevant end-use load profiles, developed by the authors, was used [23].

The aggregate end-use, time-of-day load curves based on seasonal usage patterns in the Pacific Northwest region of the United States are shown in Fig. 4(a) and (b). Most homes in the region observed were all electric; i.e., utilizing electric appliances, electric heating and ventilation, and electric water heaters (EWHs) [23]. Fig. 4(a) shows the total aggregated end-use profiles with EWHs included; in Fig. 4(b), EWHs are omitted from total aggregated load. Both scenarios were used for comparison and performance evaluation of the SOFC–CHP plant to that of conventional electrical generation for supplying power and hot water to residences. It is noted that total electricity consumption remains roughly constant between winter and summer seasons for the average all-electric Pacific Northwest home. The reader is directed to [23] for more detail about the usage profiles and trends that explain the large load peak that occurs in the late afternoon and evening during summer months, which appears directly attributable to the sizable increase in the quantity of air conditioners installed and heavier use over the past decade.

Unfortunately, while Fig. 4(a) and (b) shows time-of-day electricity consumption, the data sets from which they are derived do not have any information on the actual EWH devices monitored. Therefore, in order to analyze the CHP portion of this study, real-world residential hot water consumption data representing the nonseasonally adjusted time-of-use average compiled by the American Society of Heating, Refrigerating, and

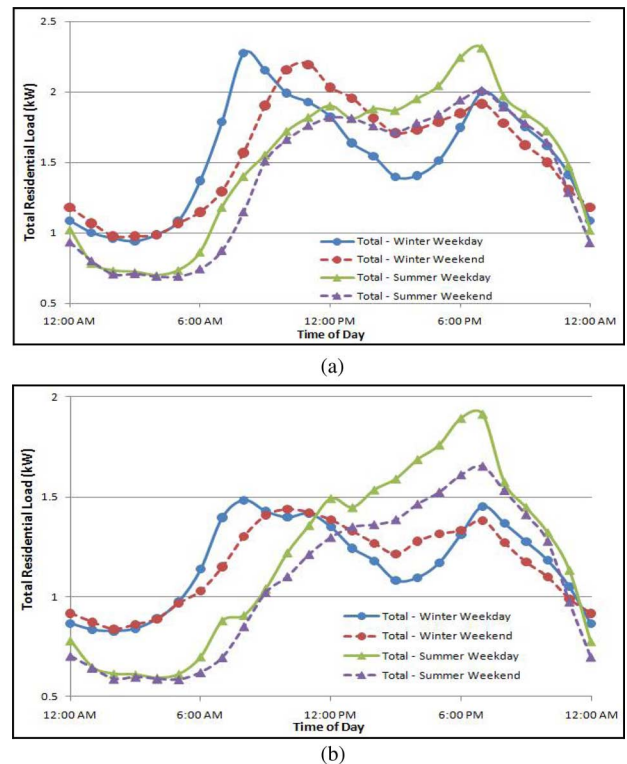

Fig. 4. (a) Aggregated total residential electrical use seasonal profiles [23]. (b) Aggregated residential electrical use profiles with EWH omitted [23].

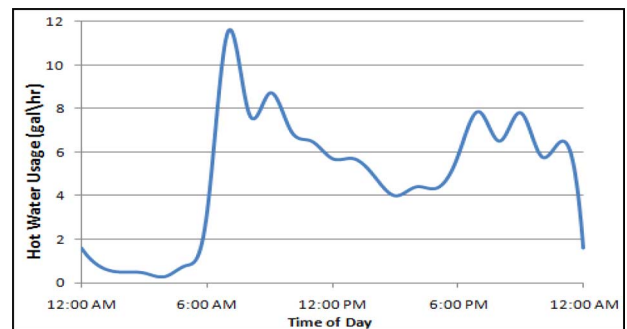

Fig. 5. ASHRAE residential hot water average hourly usage profile [24].

Air-Conditioning Engineers (ASHRAE) is utilized and shown in Fig. 5 [24]. Although not shown, the electrical end-use data and ASHRAE residential hot water usage information closely match according to time-of-day. By using Fig. 5, domestic hot water consumption can be used independent of details about the hot water source, e.g., from an EWH, gas-fired heater, etc. Ultimately, the electrical end-use information and hot water consumption information are used in conjunction to complete this study.

IV. METHODOLOGY AND SIMULATION

In order to evaluate the performance of the proposed SOFC–CHP plant when serving a 500-home neighborhood of residential customers, electricity and hot water consumption profiles described in Section III were used for simulations. All models

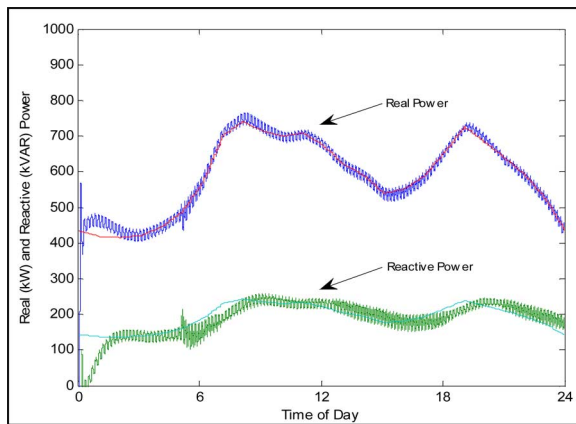

Fig. 6. Real and reactive power dispatch for the SOFC-CHP power plant in Pacific Northwest 500-home winter weekday load demand scenario.

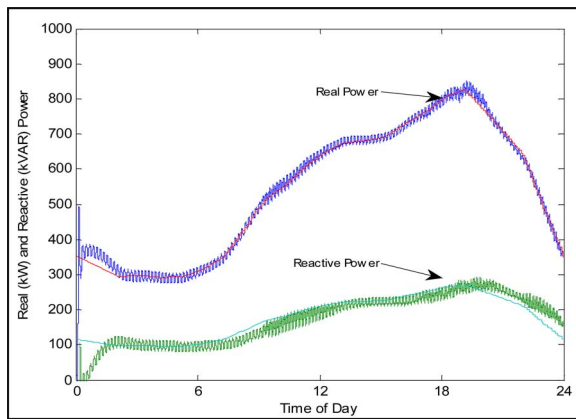

Fig. 7. Real and reactive power dispatch for the SOFC-CHP power plant Pacific Northwest 500-home summer weekend load demand scenario.

were developed in MATLAB/Simulink. It is noted that the end-use load profiles used only consider real power. To achieve a more realistic simulation, the residential power factor was set at 0.95 lagging. Real power followed the curves, shown in Fig. 4(a) and (b), and correspondingly, the total apparent power consumed at any time was the vector quantity of real and reactive power.

Simulations with the SOFC stacks under constant hydrogen fuel flow were conducted for four scenarios, weekdays and weekends during the summer and winter. The fall and spring scenarios are less extreme than the winter and summer profiles, and are omitted. Figs. 6 and 7 show two seasonally representative daily profiles (winter weekday and summer weekend) for real/reactive power supplied to the residential neighborhood by the SOFC-CHP plant. Simulations were performed on a singular 24-h basis and do not take into account previous or following day conditions. At the start of each simulation day, the SOFC-CHP plant is modeled in hot standby mode, e.g., the plant is operating within its nominal temperature, pressure, and flow limits, but loading is zero. Hence, Figs. 6 and 7 show that reactive power is slow to rise to its demanded level at the beginning of the day and real power overshoots its demanded level due to the large step change of loading commanded at the simulation start.

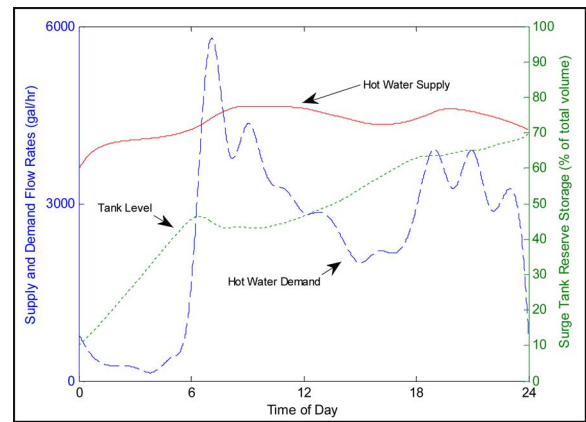

Fig. 8. Domestic hot water capacity and demand for the SOFC-CHP power plant in a Pacific Northwest 500-home winter weekday demand scenario.

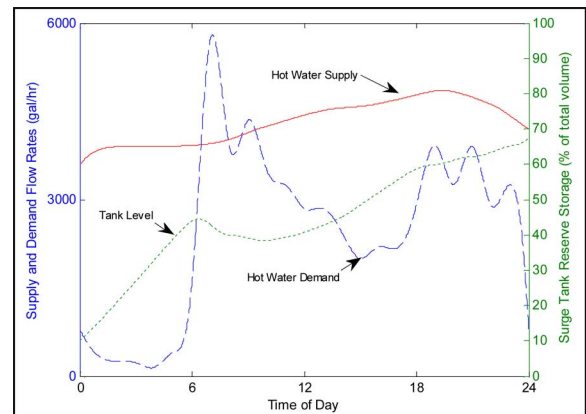

Fig. 9. Domestic hot water capacity and demand for the SOFC-CHP power plant in a Pacific Northwest 500-home summer weekend demand scenario.

Simulation results demonstrate that residential water demand under each seasonal scenario is met strictly by waste heat produced from SOFC stack operation. Figs. 8 and 9 show two typical daily profiles for residential hot water supplied by the SOFC-CHP plant. Annotated on each figure is the residential hot water demand, the available hot water supply, and the insulated surge tank level throughout the simulated day. For all simulations, the initial surge tank level is set at 10% full, and as described previously, do not take into account previous or following day conditions. Figs. 8 and 9 show that the SOFC-CHP plant adequately meets all customer time-of-use hot water demands. Clearly, the daily surplus of hot water in the surge tank is indicative that more heat is available from the CHP system than is transferred to the residences. Additionally, this shows the potential for additional cost savings by expanding the excess CHP hot water service to loads, such as: radiant heating; offsetting electricity consumed in space heating; generating process steam; or in other low temperature applications. The SOFC-CHP delivery of hot water is an extremely attractive sustainable alternative considering that otherwise, plant exhaust heat would be expelled to the environment without benefit and additional electricity would be consumed heating domestic hot water.

TABLE I
PEAK END-USE DEMAND REDUCTION BY CHP IN LIEU OF EWH

Season	On-peak Average Demand Reduction†	Largest Demand Reduction Percentage (Time-of-Day)
Winter Weekday	27.7%	34.8% (8:00am)
Winter Weekend	26.4%	35.1% (11:00am)
Summer Weekday	24.2%	35.2% (8:00am)
Summer Weekend	24.3%	33.6% (10:00am)

† Peak times-of-day are defined as: 6:00-12:00 a.m. and 5:00-10:00 p.m.

V. SOFC-CHP BENEFITS: ON-PEAK DEMAND REDUCTION AND EMISSIONS AVOIDANCE

There are two primary advantages for customers who are supplied electricity and domestic hot water from the proposed SOFC-CHP system. First, it is interesting to note that the periods of high residential electricity consumption correspond very closely to times of peak hot water usage (shown in Figs. 4(a) and 5). This is a significant observation, albeit not unexpected based on domestic habits, but was very consistent for all data reviewed for this study. Due to the strong correlation between periods of peak power and hot water demand (e.g., 8:00 a.m.), reducing the electrical load from EWHs at these times can be dramatic. When considered as a component of total residential demand, EWHs comprise about 11% of installed load [25]. However, as shown in Table I, EWHs can make up about 35% of total residential load at times of peak demand. This highlights an obscured benefit of CHP capability: nearly a quarter of average residential electric load can be cut by heating water via CHP, but more dramatically, CHP can reduce residential electrical demand by over a third during the most stressful periods for grid operation.

Eliminating significant residential electrical demand during periods of peak grid loading can reduce the need to operate peaking-generation plants. Often peaking plants are fossil fueled and typically coal fired; reducing peak demand can have a dramatic effect on the per-unit production of environmental emissions and the cost of dispatching these plants [26]. In other words, the incremental reduction of electrical load at times of peak demand has a far greater impact on cost and environmental emissions. Primarily, this is due to the expense of operating dirtier plants in inefficient modes to meet demand unmet by base load dispatch. Alternatively, the proposed SOFC-CHP plant assists the power system in two critical ways: during peak demand, leveling the load curve by eliminating EWH power consumed; and throughout the day, raising overall efficiency by producing power and hot water more sustainably than generators that combust fossil fuels.

The Pacific Northwest region of the United States has a unique blend of generation sources in operation. The Northwest Power Pool Area (NWP), a subregion of the Western Electricity Coordinating Council (WECC), primarily utilizes hydroelectric power for base load following and supplements base capacity with conventional coal-fired power. Throughout the year, roughly 50%–75% of total generated power comes from hydroelectric dams, 30%–50% from coal-fired, and 5%–15% from other sources, depending on time-of-day [27]. Almost ex-

TABLE II
REGIONAL GENERATION, EMISSIONS, AND COST DATA—2005 [28]

State	Total Generation (MWhr)	Total CO ₂ Emissions (millions metric tons)	Electricity Cost (\$/kWhr)†
NWP Subset			
Idaho	10,824,984	0.6	\$0.0629
Montana	27,938,778	19.3	\$0.0810
Oregon	49,325,003	8.2	\$0.0725
Utah	38,165,131	35.9	\$0.0752
Washington	101,965,850	14.1	\$0.0654
Wyoming	45,567,307	43.4	\$0.0748
ECAR Subset			
Indiana	130,371,573	122.6	\$0.0750
Kentucky	97,822,419	92.6	\$0.0657
Michigan	121,619,771	75.9	\$0.0840
Ohio	156,976,323	133.0	\$0.0851
W. Virginia	93,626,285	85.3	\$0.0621

† Electricity cost for delivery to the residential consumer.

clusively, coal-fired steam and fossil-fuel-fired combined-cycle plants make up NWP peaking capacity. By contrast, the East Central Area Reliability Coordinating Agreement (ECAR) region of the U.S. relies on coal-fired plants for nearly 70%–85% of base load and almost 100% of peaking supply during both summer and winter [27]. Clearly, significant base generator fossil fuel combustion could be offset by the deployment of SOFC-CHP plants, along with large reductions of the dirtiest generation at times of peak electrical loading. Based on this observation, a comparison is drawn between the regional use of conventional generation and generation by a SOFC-CHP plant for the residential study.

For the purpose of this comparative analysis, a simplified avoided-cost model was applied to the NWP and ECAR regions. First, it is difficult to obtain information that quantifies the portion of regional generation that is on-line due to peaking requirements on any given day. Additionally, because dispatch planning is performed prior to the operational period and peaking plants can be brought on-line in times of extremis, it is difficult to make predictions about the proportion of base-loaded versus peaking generation that is offset by operating a SOFC-CHP DG plant. For example, because the Pacific Northwest primarily uses hydroelectricity for load following, on a particular day that does not require peaking plant dispatch, reducing residential demand at peak times only shrinks the amount of hydroelectricity produced. On a different day, if peaking plants are needed, operating the SOFC-CHP plant may predominantly reduce peaking coal-fired plant operations. This dynamic phenomenon varies between regions, as well; unlike in the NWP, any reduction of ECAR loading lowers demand upon coal plants. To account for this effect, this study uses the blend of base and peaking generation operated throughout the year accounted for by regional annual average costs and emissions data. This information is summarized in Tables II and III [28], but it is noted that the results shown underestimate both avoided costs and emissions because of the peaking effect described previously. Interestingly, Table III shows that, although the average regional per kilowatt-hour cost is roughly the same between the NWP and ECAR, CO₂ emissions from ECAR generation are almost twice those of the NWP. This reflects the low cost of hydroelectric

TABLE III
REGIONAL AVERAGE EMISSIONS AND COST DATA—2005 [28]

Regional Subset	CO ₂ Emissions per Generation (metric tons/kWhr)	Electricity Cost (\$/kWhr)†
NWP	4.437x10 ⁻⁴	\$0.0720
ECAR	8.484x10 ⁻⁴	\$0.0744

† Electricity cost for delivery to the residential consumer.

TABLE IV
ANNUAL SAVINGS AND AVOIDED EMISSIONS WITH SOFC-CHP

	NWP	ECAR
Total Operational Cost Savings (\$)	\$112,084	\$115,820
Avoided CO ₂ Emissions (tons of CO ₂)	690.7	1320.7
Avoided SO ₂ Emissions (tons of SO ₂)†	5.5	
Avoided NO _x Emissions (tons of NO _x)†	2.1	

† State-specific SO₂ and NO_x emissions information is not available. In lieu of this data, U.S. national averages of 3.53826×10^{-6} and 1.35542×10^{-6} tons per kWh of SO₂ and NO_x, respectively, are used [28]. It is noted that use of national averages suppresses emissions impact within the ECAR region and inflates it in the NWP due to their varying reliance on fossil fuels for power.

and coal-fired generation, and the difference of environmental impact between the two sources. The two regions analyzed had some of the lowest electricity costs for residential consumers; below the U.S. average cost of \$0.0945/kWh and about half of the cost of electricity in New England (\$0.1344/kWh) [29].

Based on this data and simulation results, the SOFC-CHP power plant allowed each home to eliminate purchases of 3113.4-kWh per residence, per annum, from the utility grid. Further, significant emissions were avoided, as annotated for the entire 500-home neighborhood in Table IV. While not considered here, it is noted that other factors, such as fuel costs, the capital cost of implementing a power plant, and other expenses vary dramatically between regions and between technologies. Table IV allows data from the NWP and ECAR regions to be compared directly to the SOFC-CHP plant in terms of avoided costs. Clearly, operation of the proposed SOFC-CHP plant avoids significant costs and emissions in the two regions examined.

VI. CONCLUSION

SOFCs are a transitional technology, able to flexibly use multiple fuels, which allows the utilization of existing natural gas infrastructure and facilitates capitalizing on potential future supplies of hydrogen. In this paper, the methodology, operation, and simulation of a large-scale 1.0-MW SOFC-CHP power plant was discussed, as well as the system configuration and major component models. End-use electricity and hot water consumption profiles were developed for residential customers and served as the basis for a comparative study of the proposed hybrid power plant to regional electrical utilities.

In this study, SOFC stacks were paired with CHP capability to utilize waste heat, thereby enhancing total system efficiency and sourcing sufficient power and hot water to a 500-home residential neighborhood. The simulation results show that for the residential case analyzed, hundreds of tons of carbon, sulfur, and nitrogen oxide emissions are avoided by reducing demand from

conventional power sources. Towards sustainability, simulation results give insight into benefits of the SOFC-CHP system that go beyond simple efficiency improvement over conventional power plants. In fact, it is shown that the SOFC-CHP plant can have dramatic impacts for both on- and off-peak residential loading, including a reduction of over a third of residential electricity demand at key peak times. This is in addition to a total demand decrease of over 20% annually, which is far more than the reported 11% component of average residential loading due to EWHs. The SOFC-CHP system demonstrated by dynamic, time-of-day studies utilizing real-world consumption data clearly shows that coupling benefits of SOFC and CHP technologies can provide a viable solution to improve electricity delivery to the residential customer with reduced environmental emissions.

REFERENCES

- [1] M. C. Williams, J. P. Strakey, W. A. Surdoval, and L. C. Wilson, "Solid oxide fuel cell technology development in the U. S.," *Solid State Ionics*, vol. 177, no. 19, pp. 2039–2044, 2006.
- [2] W. A. Surdoval, "US DoE Fossil Energy Fuel Cell Program," presented at the 7th SECA Workshop and Peer Review, Philadelphia, PA, Sep. 2006. Available: <http://www.netl.doe.gov/publications/proceedings/06/seca/>
- [3] H. Zhu and R. J. Kee, "Thermodynamics of SOFC efficiency and fuel utilization as functions of fuel mixtures and operating conditions," *J. Power Sources*, vol. 161, no. 2, pp. 957–964, Oct. 2006.
- [4] Y. Tanaka, A. Momma, K. Kato, A. Negishi, K. Takano, K. Nozaki, and T. Kato, "Development of electrical efficiency measurement techniques for 10 kW-class SOFC system—Part I: Measurement of electrical efficiency," *Energy Convers. Manage.*, vol. 50, no. 3, pp. 458–466, Mar. 2009.
- [5] S. Farhad and F. Hamdullahpur, "Developing fuel map to predict the effect of fuel composition on the maximum efficiency of solid oxide fuel cells," *J. Power Sources*, vol. 193, no. 2, pp. 632–638, Sep. 2009.
- [6] U.S. Department of Energy, "Annual Energy Outlook 2006," DOE/EIA-0383, Energy Information Administration, Washington, DC, 2006.
- [7] R. U. Ayres, L. W. Ayres, and B. Warr, "Energy, power and work in the US economy, 1900–1998," *Energy*, vol. 28, no. 3, pp. 219–273, Mar. 2003.
- [8] R. U. Ayres, H. Turton, and T. Casten, "Energy efficiency, sustainability and economic growth," *Energy*, vol. 32, no. 5, May 2007.
- [9] W. Graus and E. Worrell, "Trend in efficiency and capacity of fossil power generation in the EU," *Energy Policy*, vol. 37, no. 6, Jun. 2009.
- [10] A. D. Hawkes, P. Aguiab, B. Croxford, M. A. Leach, C. S. Adjiman, and N. P. Brandon, "Solid oxide fuel cell micro combined heat and power system operating strategy: Options for provision of residential space and water heating," *J. Power Sources*, vol. 164, no. 1, Jan. 2007.
- [11] M. C. Williams, J. P. Strakey, and S. C. Singhal, "US distributed generation fuel cell program," in *Fuel Cells Compendium*, P. B. Nigdel and D. Thompson, Eds. Elsevier, U.K.: Oxford, 2005, ch. 1.
- [12] C. Wang and M. H. Nehrir, "A physically-based dynamic model for solid oxide fuel cells," *IEEE Trans. Energy Convers.*, vol. 22, no. 4, pp. 887–897, Dec. 2007.
- [13] M. H. Nehrir and C. Wang, *Modeling and Control of Fuel Cells: Distributed Generation Applications*. Hoboken, NJ: Wiley-IEEE Press, 2009.
- [14] C. Colson, M. Nehrir, M. Deibert, M. Amin, and C. Wang, "Efficiency evaluation of solid-oxide fuel cells in combined cycle operations," *ASME J. Fuel Cell Sci. Technol.*, vol. 6, no. 2, Feb. 2009.
- [15] C. M. Colson, M. H. Nehrir, and C. Wang, "Modeling a large-scale utility-interconnected solid oxide fuel cell power plant," presented at the 40th North American Power Symp., Calgary, AB, 2008.
- [16] F. Kreith and R. Emmett West, *CRC Handbook of Energy Efficiency*. Boca Raton, FL: CRC-Press, 1996.
- [17] M. F. Serincan, U. Pasaogullari, and N. M. Sammes, "Effects of operating conditions on the performance of a micro-tubular solid oxide fuel cell (SOFC)," *J. Power Sources*, vol. 192, no. 2, Jul. 2009.
- [18] A. Nakajo, Z. Wuillemin, J. Van herle, and D. Favrat, "Simulation of thermal stresses in anode-supported solid oxide fuel cell stacks—Part I: Probability of failure of the cells," *J. Power Sources*, vol. 193, no. 1, Aug. 2009.

- [19] S. Heunis and R. Herman, "A probabilistic model for residential consumer loads," *IEEE Trans. Power Syst.*, vol. 17, no. 3, Aug. 2002.
- [20] R. T. Guttromson, D. P. Chassin, and S. E. Widergren, "Residential energy resource models for distribution feeder simulation," in *Proc. IEEE Power Eng. Soc. Gen. Meet.*, vol. 1, Jul. 2003.
- [21] D. McQueen, P. Hyland, and S. Watson, "Monte Carlo simulation of residential electricity demand for forecasting maximum demand on distribution networks," *IEEE Trans. Power Syst.*, vol. 19, no. 3, Aug. 2004.
- [22] T. V. Cutsem and C. Vournas, *Voltage Stability of Electric Power Systems*. New York, NY: Springer, 1998.
- [23] C. Colson and M. H. Nehrir, "An alternative method to load modeling for obtaining end-use load profiles," presented at the 41st North American Power Symp., Starksville, MS, Oct. 2009.
- [24] B. R. Becker and K. E. Stogsdill, "A domestic hot water use database," *J. Amer. Soc. Heating, Refrigerating, Air-Conditioning Engineers (ASHRAE)*, vol. 32, no. 9, pp. 21–25, 1990.
- [25] N. Lu and S. Katipamula, "Control strategies of thermostatically controlled appliances in a competitive electricity market," in *Proc. IEEE Power Eng. Soc. Gen. Meet.*, pp. 202–207, Jun. 2005.
- [26] M. Haines and J. Davison, "Designing carbon capture power plants to assist in meeting peak power demand," *Energy Procedia*, vol. 1, no. 1, pp. 1457–1464, Feb. 2009.
- [27] M. Kintner-Meyer, K. Schneider, and R. Pratt, "Impacts assessment of plug-in hybrid vehicles on electric utilities and regional US power grids—Part 1: Technical analysis," *Regional Grids and Plug-in Hybrids*, Pacific Northwest National Laboratory, Richland, WA, 2007.
- [28] Compiled from multiple Energy Information Administration spreadsheets including "Emissions Detail by State," "Table 5.1-Emissions from Energy Consumption at CPPs and CHPs, 1996 – 2007," and "Electric Power Annual 2007- State Tables," [Online]. Available: <http://www.eia.doe.gov>
- [29] U.S. Department of Energy, "2005 Electric Sales, Revenue, Price: Tables 2 and 3," Energy Information Administration, Washington, DC, 2005, [Online]. Available: <http://www.eia.doe.gov/cneaf/electricity/esr>



Christopher M. Colson (S'07) received the B.S. degree in control systems engineering from the United States Naval Academy in 1999, the MEM degree from Old Dominion University, Norfolk, VA, in 2006, and M.S. degree in electrical engineering from Montana State University, Bozeman, MA, in 2008.

He served as a Submarine Warfare Officer in the U.S. Navy and is currently a National Science Foundation (NSF) Graduate Research Fellow and doctoral student in electrical engineering (power systems focus) at Montana State University.



M. Hashem Nehrir (S'68–M'71–SM'89–F'10) received the B.S., M.S., and Ph.D. degrees from Oregon State University, Corvallis, in 1969, 1971, and 1978, respectively, all in electrical engineering.

He was with the Electrical Engineering Department, Shiraz University, Iran from 1971 to 1986. Since 1987, he has been with the Electrical and Computer Engineering Department, Montana State University, Bozeman, MT, where he is a Professor. His research interests include modeling and control of power systems, alternative energy power generation systems, and application of intelligent controls to power systems. He is the author of three textbooks and an author or coauthor of numerous technical papers.