



SIMULATION OF D-STATCOM AND DVR IN POWER SYSTEMS

S.V Ravi Kumar¹ and S. Siva Nagaraju¹
¹J.N.T.U. College of Engineering, KAKINADA, A.P, India
 E-mail: ravijntu@gmail.com

ABSTRACT

A Power quality problem is an occurrence manifested as a nonstandard voltage, current or frequency that results in a failure or a mis-operation of end user equipments. Utility distribution networks, sensitive industrial loads and critical commercial operations suffer from various types of outages and service interruptions which can cost significant financial losses. With the restructuring of power systems and with shifting trend towards distributed and dispersed generation, the issue of power quality is going to take newer dimensions. In developing countries like India, where the variation of power frequency and many such other determinants of power quality are themselves a serious question, it is very vital to take positive steps in this direction. The present work is to identify the prominent concerns in this area and hence the measures that can enhance the quality of the power are recommended.

This work describes the techniques of correcting the supply voltage sag, swell and interruption in a distributed system. At present, a wide range of very flexible controllers, which capitalize on newly available power electronics components, are emerging for custom power applications. Among these, the distribution static compensator and the dynamic voltage restorer are most effective devices, both of them based on the VSC principle. A DVR injects a voltage in series with the system voltage and a D-STATCOM injects a current into the system to correct the voltage sag, swell and interruption. Comprehensive results are presented to assess the performance of each device as a potential custom power solution.

Keywords: D-Statcom, DVR, voltage dips, swells, interruption, power quality, VSC.

1. INTRODUCTION

One of the most common power quality problems today is voltage dips. A voltage dip is a short time (10 ms to 1 minute) event during which a reduction in r.m.s voltage magnitude occurs. It is often set only by two parameters, depth/magnitude and duration. The voltage dip magnitude is ranged from 10% to 90% of nominal voltage (which corresponds to 90% to 10% remaining voltage) and with a duration from half a cycle to 1 min. In a three-phase system a voltage dip is by nature a three-phase phenomenon, which affects both the phase-to-ground and phase-to-phase voltages. A voltage dip is caused by a fault in the utility system, a fault within the customer's facility or a large increase of the load current, like starting a motor or transformer energizing. Typical faults are single-phase or multiple-phase short circuits, which leads to high currents. The high current results in a voltage drop over the network impedance. At the fault location the voltage in the faulted phases drops close to zero, whereas in the non-faulted phases it remains more or less unchanged [1, 2].

Voltage dips are one of the most occurring power quality problems. Off course, for an industry an outage is worse, than a voltage dip, but voltage dips occur more often and cause severe problems and economical losses. Utilities often focus on disturbances from end-user equipment as the main power quality problems. This is correct for many disturbances, flicker, harmonics, etc., but voltage dips mainly have their origin in the higher voltage levels. Faults due to lightning, is one of the most common causes to voltage dips on overhead lines. If the economical losses due to voltage dips are significant, mitigation actions can be profitable for the customer and even in

some cases for the utility. Since there is no standard solution which will work for every site, each mitigation action must be carefully planned and evaluated. There are different ways to mitigate voltage dips, swell and interruptions in transmission and distribution systems. At present, a wide range of very flexible controllers, which capitalize on newly available power electronics components, are emerging for custom power applications [3, 4]. Among these, the distribution static compensator and the dynamic voltage restorer are most effective devices, both of them based on the VSC principle. A new PWM-based control scheme has been implemented to control the electronic valves in the two-level VSC used in the D-STATCOM and DVR [5, 6].

2. VOLTAGE SOURCE CONVERTERS (VSC)

A voltage-source converter is a power electronic device, which can generate a sinusoidal voltage with any required magnitude, frequency and phase angle. Voltage source converters are widely used in adjustable-speed drives, but can also be used to mitigate voltage dips. The VSC is used to either completely replace the voltage or to inject the 'missing voltage'. The 'missing voltage' is the difference between the nominal voltage and the actual. The converter is normally based on some kind of energy storage, which will supply the converter with a DC voltage. The solid-state electronics in the converter is then switched to get the desired output voltage. Normally the VSC is not only used for voltage dip mitigation, but also for other power quality issues, e.g. flicker and harmonics.



**2.1 Series voltage controller
[Dynamic Voltage Restorer, (DVR)]**

The series voltage controller is connected in series with the protected load as shown in Fig.1. Usually the connection is made via a transformer, but configurations with direct connection via power electronics also exist. The resulting voltage at the load bus bar equals the sum of the grid voltage and the injected voltage from the DVR. The converter generates the reactive power needed while the active power is taken from the energy storage.

The energy storage can be different depending on the needs of compensating. The DVR often has limitations on the depth and duration of the voltage dip that it can compensate.

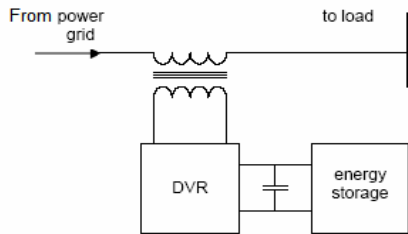

Figure-1. Example of a standard configuration for a DVR.

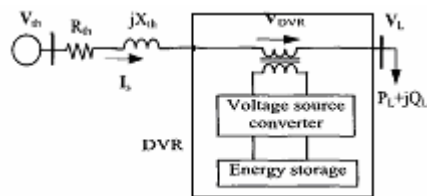

Figure-2. Schematic diagram of a DVR

The circuit on left hand side of the DVR represents the Thevenin equivalent circuit of the system. The system impedance Z_{th} depends on the fault level of the load bus. When the system voltage (V_{th}) drops, the DVR injects a series voltage V_{DVR} through the injection transformer so that the desired load voltage magnitude V_L can be maintained. The series injected voltage of the DVR can be written as,

$$V_{DVR} = V_L + Z_{th}I_L - V_{th}$$

Where

- V_L is the desired load voltage magnitude
- Z_{th} is the load impedance
- I_L is the load current
- V_{th} is the system voltage during fault condition

The load current I_L is given by,

$$I_L = \left(\frac{(P_L + j^*Q_L)}{V_L} \right)^*$$

When V_L is considered as a reference, eqn. (4.1) can be rewritten as,

$$V_{DVR} \angle \alpha = V_L \angle 0 + Z_{th} I_L \angle (\beta - \theta) - V_{th} \angle \delta$$

Here α , β and δ are the angle of V_{DVR} , Z_{th} and V_{th} , respectively, and θ is the load power factor angle,

$$\theta = \tan^{-1}(Q_L/P_L).$$

The complex power injection of the DVR can be written as,

$$S_{DVR} = V_{DVR} I_L^*$$

It may be mentioned here that when the injected voltage V_{DVR} is kept in quadrature with I_L , no active power injection by the DVR is required to correct the voltage. It requires the injection of only reactive power and the DVR itself is capable of generating the reactive power. Note that DVR can be kept in quadrature with I_L only up to a certain value of voltage sag and beyond which the quadrature relationship cannot be maintained to correct the voltage sag. For such a case, injection of active power into the system is essential. The injected active power must be provided by the energy storage system of the DVR.

2.1.1 Controller

The aim of the control scheme is to maintain constant voltage magnitude at the point where a sensitive load is connected, under system disturbances. The control system only measures the r.m.s voltage at the load point, i.e., no reactive power measurements are required. The VSC switching strategy is based on a sinusoidal PWM technique which offers simplicity and good response. Since custom power is a relatively low-power application, PWM methods offer a more flexible option than the Fundamental Frequency Switching (FFS) methods favored in FACTS applications. Besides, high switching frequencies can be used to improve on the efficiency of the converter, without incurring significant switching losses.

The controller input is an error signal obtained from the reference voltage and the value rms of the terminal voltage measured. Such error is processed by a PI controller the output is the angle δ , which is provided to the PWM signal generator. It is important to note that in this case, indirectly controlled converter, there is active and reactive power exchange with the network simultaneously: an error signal is obtained by comparing the reference voltage with the rms voltage measured at the load point. The PI controller process the error signal generates the required angle to drive the error to zero, i.e., the load rms voltage is brought back to the reference voltage.

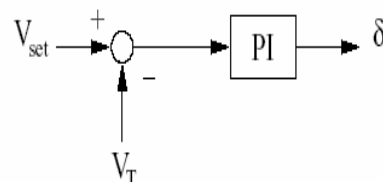

Figure-3. Indirect PI controller.

The sinusoidal signal $V_{control}$ is phase-modulated by means of the angle δ .

i.e.,

$$V_A = \sin(\omega t + \delta)$$

$$V_B = \sin(\omega t + \delta - 2\pi/3)$$

$$V_C = \sin(\omega t + \delta + 2\pi/3)$$

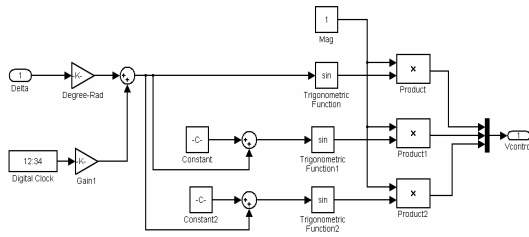

Figure-4. Phase-Modulation of the control angle δ .

The modulated signal $V_{control}$ is compared against a triangular signal in order to generate the switching signals for the VSC valves. The main parameters of the sinusoidal PWM scheme are the amplitude modulation index of signal, and the frequency modulation index of the triangular signal.

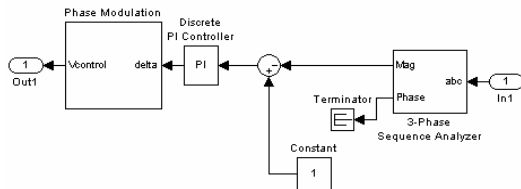

Figure-5. Simulink model of DVR Controller.

The amplitude index is kept fixed at 1 pu, in order to obtain the highest fundamental voltage component at the controller output.

$$m_a = \frac{\hat{V}_{control}}{\hat{V}_{Tri}} = 1 \text{ p.u}$$

Where

$\hat{V}_{control}$ is the peak amplitude of the control signal
 \hat{V}_{Tri} is the peak amplitude of the triangular signal
 The switching frequency is set at 1080 Hz. The frequency modulation index is given by,

$$m_f = f_s / f_1 = 1080 / 60 = 18$$

Where f_1 is the fundamental frequency.

The modulating angle is applied to the PWM generators in phase A. The angles for phases B and C are shifted by 240° and 120° , respectively. It can be seen in that the control implementation is kept very simple by using only voltage measurements as the feedback variable in the control scheme. The speed of response and robustness of the control scheme are clearly shown in the simulation results.

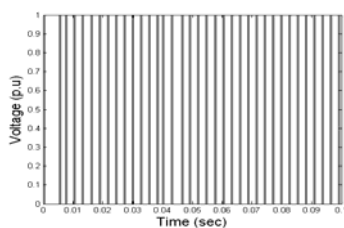

Figure-6. Pulses generated by Discrete PWM Generator.

2.1.2 Test system

Single line diagram of the test system for DVR is shown in Figure-7 and the test system employed to carried out the simulations for DVR is shown in Figure-8. Such system is composed by a 13 kV, 50 Hz generation system, feeding two transmission lines through a 3-winding transformer connected in Y/ Δ / Δ , 13/115/15 kV. Such transmission lines feed two distribution networks through two transformers connected in Δ /Y, 15/11 kV.

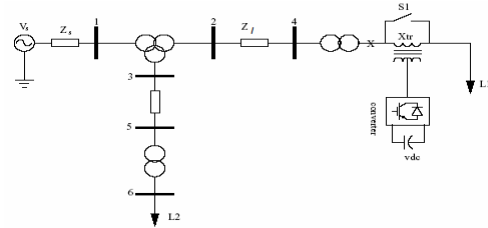

Figure-7. Single line diagram of the test system for DVR.

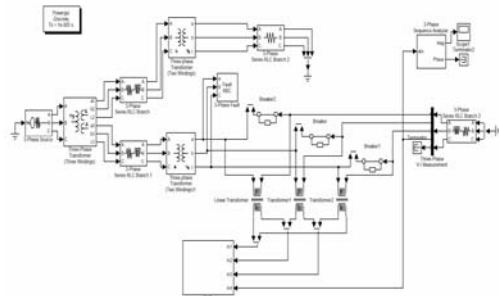

Figure-8. Simulink model of DVR test system for voltage sag.

To verify the working of a DVR employed to avoid voltage sags during short-circuit, a fault is applied at point X via a resistance of 0.4 Ω . Such fault is applied for 100msec. The capacity of the dc storage device is 5 kV.

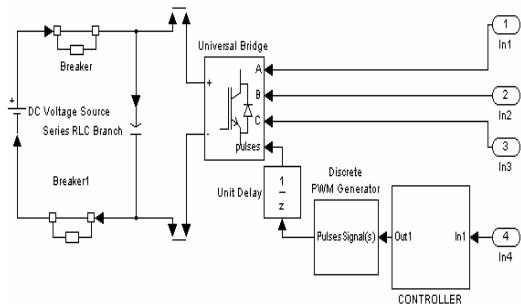

Figure-9. Simulink model of DVR.

Using the facilities available in MATLAB SIMULINK, the DVR is simulated to be in operation only for the duration of the fault, as it is expected to be the case in a practical situation. Power System Block set for use with Matlab/Simulink is based on state-variable analysis and employs either variable or fixed integration-step algorithms. Figure-9 shows the simulink model of DVR and Figure-8 shows the Simulink model of the test system for DVR.



2.2 Shunt voltage controller

[Distribution Static Compensator (DSTATCOM)]

A D-STATCOM (Distribution Static Compensator), which is schematically depicted in Figure-10, consists of a two-level Voltage Source Converter (VSC), a dc energy storage device, a coupling transformer connected in shunt to the distribution network through a coupling transformer. The VSC converts the dc voltage across the storage device into a set of three-phase ac output voltages. These voltages are in phase and coupled with the ac system through the reactance of the coupling transformer. Suitable adjustment of the phase and magnitude of the D-STATCOM output voltages allows effective control of active and reactive power exchanges between the D-STATCOM and the ac system. Such configuration allows the device to absorb or generate controllable active and reactive power.

The VSC connected in shunt with the ac system provides a multifunctional topology which can be used for up to three quite distinct purposes:

1. Voltage regulation and compensation of reactive power;
2. Correction of power factor; and
3. Elimination of current harmonics.

Here, such device is employed to provide continuous voltage regulation using an indirectly controlled converter.

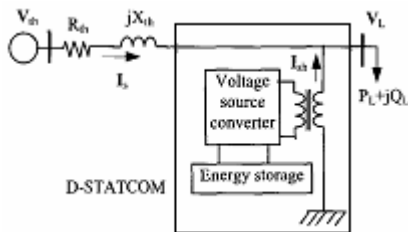

Figure-10. Schematic diagram of a D-STATCOM.

Figure-10 the shunt injected current I_{sh} corrects the voltage sag by adjusting the voltage drop across the system impedance Z_{th} . The value of I_{sh} can be controlled by adjusting the output voltage of the converter.

The shunt injected current I_{sh} can be written as,

$$I_{sh} = I_L - I_s = I_L - \frac{V_{Th} - V_L}{Z_{Th}}$$

$$I_{sh} \angle \eta = I_L \angle -\theta - \frac{V_{th}}{Z_{th}} \angle (\delta - \beta) + \frac{V_L}{Z_{th}} \angle -\beta$$

The complex power injection of the D-STATCOM can be expressed as,

$$S_{sh} = V_L I_{sh}^*$$

It may be mentioned that the effectiveness of the D-STATCOM in correcting voltage sag depends on the value of Z_{th} or fault level of the load bus. When the shunt injected current I_{sh} is kept in quadrature with V_L , the desired voltage correction can be achieved without injecting any active power into the system. On the other hand, when the value of I_{sh} is minimized, the same voltage

correction can be achieved with minimum apparent power injection into the system. The control scheme for the D-STATCOM follows the same principle as for DVR. The switching frequency is set at 475 Hz.

2.2.1 Test system

Figure-11 shows the test system used to carry out the various D-STATCOM simulations.

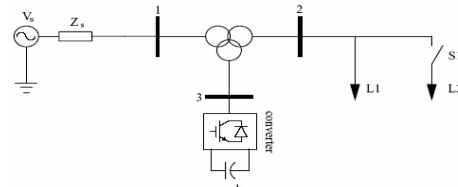

Figure-11. Single line diagram of the test system for D-STATCOM.

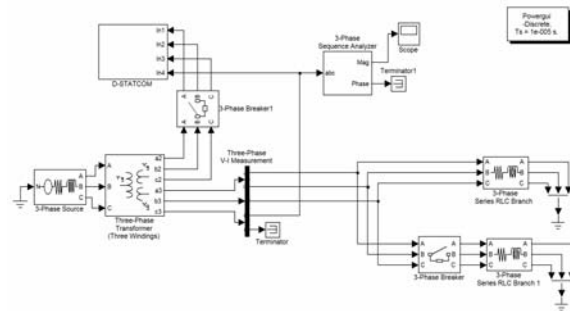

Figure-12. Simulink model of D-STATCOM test system.

Figure-12 shows the test system implemented in MATLAB SIMULINK. The test system comprises a 230kV, 50Hz transmission system, represented by a Thevenin equivalent, feeding into the primary side of a 3-winding transformer connected in Y/Y/Y, 230/11/11 kVA varying load is connected to the 11 kV, secondary side of the transformer. A two-level D-STATCOM is connected to the 11 kV tertiary winding to provide instantaneous voltage support at the load point. A 750 μ F capacitor on the dc side provides the D-STATCOM energy storage capabilities. To show the effectiveness of this controller in providing continuous voltage regulation, simulations were carried out with and with no D-STATCOM connected to the system.

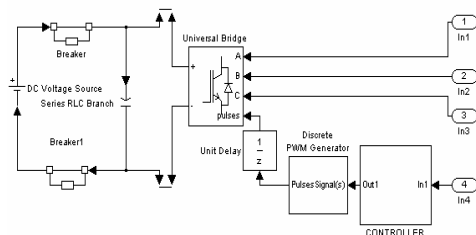

Figure-13. Simulink model of D-STATCOM.

The D-STATCOM model which is incorporated in the transmission system for voltage regulation is as shown in Figure-13.



3. SIMULATON RESULTS

3.1 Simulation results of D-STATCOM

Case 1: Simulation results of voltage sag during single line to ground fault

The first simulation contains no D-STATCOM and single line to ground fault is applied at point A in Figure-14, via a fault resistance of 0.2Ω , during the period 500–900 ms. The voltage sag at the load point is 45% with respect to the reference voltage.

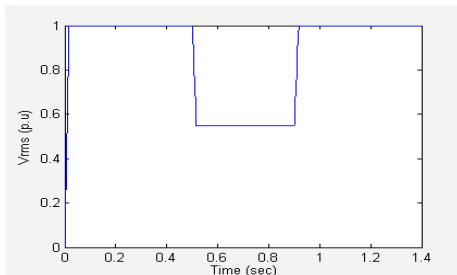

Figure-14. Voltage V_{rms} at the load point: without D-STATCOM.

Similarly, a new set of simulations was carried out but now with the D-STATCOM connected to the system as shown in Figure-14 where the very effective voltage regulation provided by the D-STATCOM can be clearly appreciated.

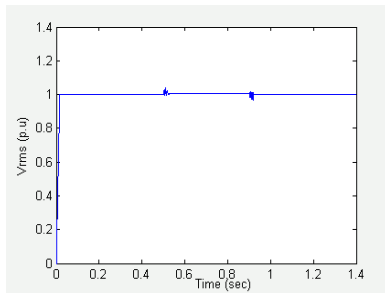

Figure-15. Voltage V_{rms} at the load point: with D-STATCOM Energy Storage of 20.9kv

Case 2: Simulation result of voltage interruption during three phase fault

The first simulation contains no D-STATCOM and three phase fault is applied at point A, via a fault resistance of 0.001Ω , during the period 500-900 ms. The voltage at the load point is 0% with respect to the reference voltage is shown in Figure-16. Similarly, a new set of simulations was carried out but now with the D-STATCOM connected to the system, the load voltage shown in Figure-17.

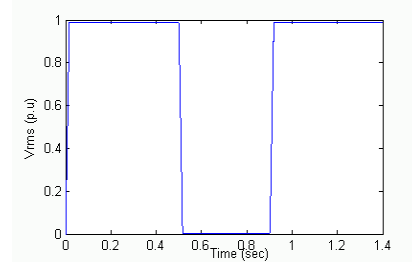

Figure-16. Voltage V_{rms} at the load point: without D-STATCOM.

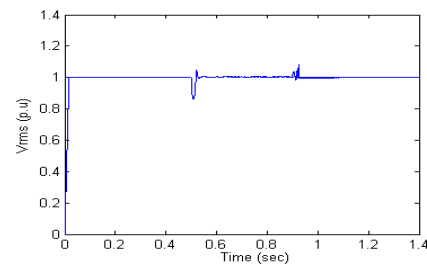

Figure-17. Voltage V_{rms} at the load point: with Energy Storage of 40.7kv

Case 3: Simulation results of voltage swell

The first simulation contains no D-STATCOM and three phase capacitive load applied at point A, during the period 500–900 ms. The voltage swell at the load point is 40% with respect to the reference voltage is shown in Figure-18 and The test system for the simulation of D-STATCOM for swell is shown in Figure-19.

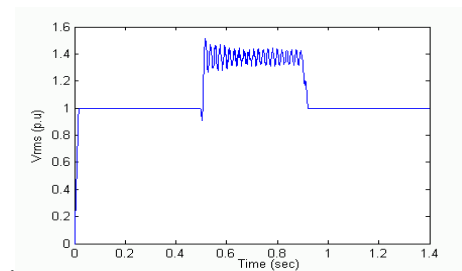

Figure-18. Voltage V_{rms} at the load point: Without D-STATCOM.

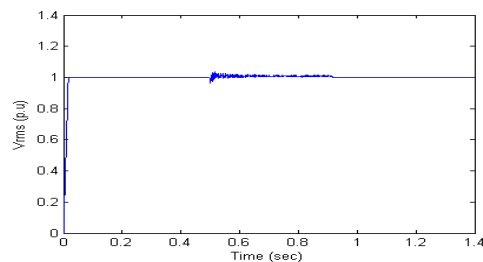

Figure-19. Voltage V_{rms} at the load point: with D-STATCOM Energy Storage of 16.8kv



3.2 Simulation results of DVR

Case 1: Simulation results of voltage sag during single line to ground fault

The first simulation contains no DVR and a single line to ground fault is applied at point A in Figure-20, via a fault resistance of 0.2Ω , during the period 500–900 ms. The voltage sag at the load point is 30% with respect to the reference voltage. The second simulation is carried out using the same scenario as above but now with the DVR in operation. The total simulation period is 1400 ms.

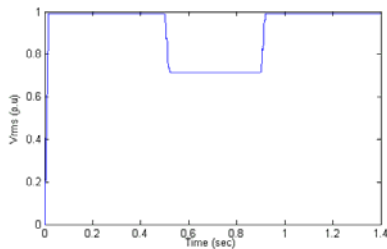

Figure-20. Voltage V_{rms} at load point: without DVR.

When the DVR is in operation the voltage sag is mitigated almost completely, and the rms voltage at the sensitive load point is maintained at 98%, as shown in Figure-21.

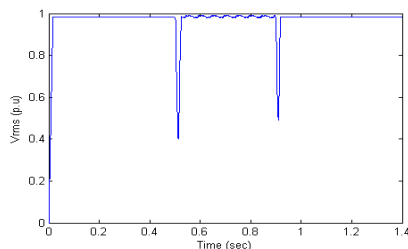

Figure-21. Voltage V_{rms} at load point: With DVR Energy Storage of 7kv.

Case 2: Simulation result of voltage interruption during three phase fault

The first simulation contains no DVR and capacitive load of is applied at load1, during the period 500–900 ms. The voltage swell at the load point is 25% with respect to the reference voltage.

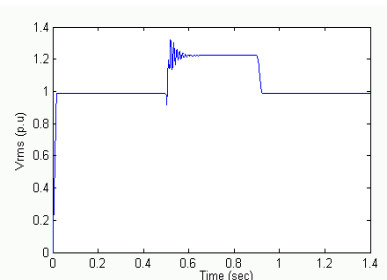

Figure-22. Voltage V_{rms} at the load point: without DVR.

The second simulation is carried out using the same scenario as above but now with the DVR in operation. The total simulation period is 1400 ms. Figure-22 shows the rms voltage at the load point for the case when the system operates with no DVR. When the DVR is in operation the voltage swell is mitigated almost completely, and the rms voltage at the sensitive load point is maintained normal.

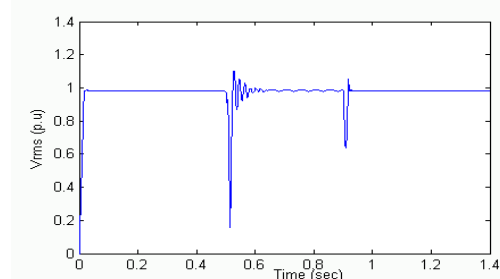

Figure-23. Voltage V_{rms} at the load point: with DVR Energy Storage 6.8kv.

The PWM control scheme controls the magnitude and the phase of the injected voltages, restoring the rms voltage very effectively. The swell mitigation is performed with a smooth, stable, and rapid DVR response; two transient undershoots are observed as in Figure-23 when the DVR comes in and out of operation.

Case 3: Simulation result of voltage interruption during three-phase fault

The first simulation contains no DVR and three phase fault is applied at point A, in Fig.24, via a fault resistance of 0.001Ω , during the period 500–900 ms. The voltage at the load point is 0% with respect to the reference voltage. The second simulation is carried out using the same scenario as above but now with the DVR in operation. The total simulation period is 1400 ms.

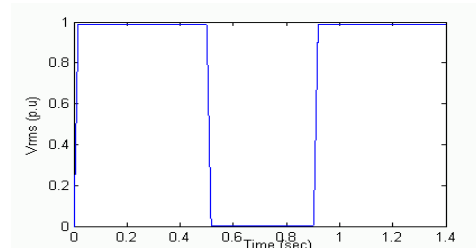

Figure-24. Voltage V_{rms} at the load point: without DVR. When the DVR is in operation the voltage sag is mitigated almost completely, and the rms voltage at the sensitive load point is maintained at 98%, as shown in Figure-25.

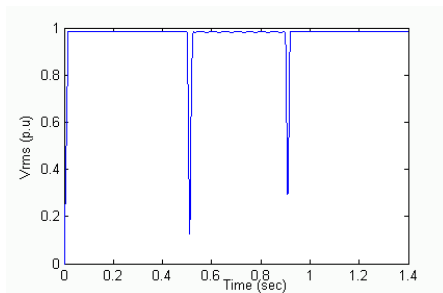

Figure-25. Voltage V_{rms} at the load point: with DVR Energy Storage of 4.9kv.

4. CONCLUSIONS

This paper has presented the power quality problems such as voltage dips, swells and interruptions, consequences, and mitigation techniques of custom power electronic devices DVR, D-STATCOM, and SSTS. The design and applications of DVR, D-STATCOM and SSTS for voltage sags, interruptions and swells, and comprehensive results are presented.

A new PWM-based control scheme has been implemented to control the electronic valves in the two-level VSC used in the D-STATCOM and DVR. As opposed to fundamental frequency switching schemes already available in the MATLAB/ SIMULINK, this PWM control scheme only requires voltage measurements. This characteristic makes it ideally suitable for low-voltage custom power applications. The simulations carried out showed that the DVR provides relatively better voltage regulation capabilities. It was also observed that

the capacity for power compensation and voltage regulation of DVR and D-STATCOM depends on the rating of the dc storage device.

REFERENCES

- [1] G. Yaleinkaya, M.H.J. Bollen, P.A. Crossley, "Characterization of voltage sags in industrial distribution systems", IEEE transactions on industry applications, vol.34, no. 4, July/August, pp. 682-688, 1999.
- [2] Haque, M.H., "Compensation of distribution system voltage sag by DVR and D-STATCOM", Power Tech Proceedings, 2001 IEEE Porto, vol.1, pp.10-13, Sept. 2001.
- [3] Anaya-Lara O, Acha E., "Modeling and analysis of custom power systems by PSCAD/EMTDC", IEEE Transactions on Power Delivery, Vol.17, Issue: 1, Jan. 2002, Pages:266 – 272
- [4] Bollen, M.H.J., "Voltage sags in three-phase systems" Power Engineering Review, IEEE, Vol. 21, Issue: 9, Sept. 2001, pp: 8 - 11, 15.
- [5] M.Madrigal, E.Acha., "Modelling of Custom Power Equipment Using Harmonic Domain Techniques", IEEE 2000.
- [6] R.Mienski,R.Pawelek and I.Wasiak., "Shunt Compensation for Power Quality Improvement Using a STATCOM controller: Modelling and Simulation", IEEE Proce., Vol.151, No.2, March 2004.